





SPECIFICATIONS

CUSTOMER : _____
MODEL NO. : **GFE320240L-FPFE3C**
VERSION : **C**
DATE : **2022.12.07**
CERTIFICATION : **ROHS**

Customer Sign	Approved By	Prepared By	Prepared By
			

晶發科技股份有限公司
GI FAR TECHNOLOGY CO.,LTD.

新北市樹林區東豐街 81 號

No. 81, Dongfeng St, Shulin District, 238034, New Taipei City, Taiwan, R.O.C.

TEL: +886-2-8684-1188 FAX: +886-2-8684-8532



CONTENTS

1. General Specifications	4
2. Electrical Specifications	5
2.1 Absolute Maximum Ratings	5
2.2 DC Characteristics	5
2.3 AC Characteristics	6
2.4 Power Supply ON/OFF Sequence	8
2.5 Spec. for LED back-light	9
3. Optical Specifications	10
3.1 LCD Driving Voltage Recommended	10
3.2 Optical Characteristics	10
3.3 Definition of Viewing Angle	11
3.4 Definition of Viewing Angle θF and θB	11
3.5 Definition of Contrast Ratio(Cr)	11
4. I/O Terminal	12
4.1 Pin Assignment	12
4.2 Example of Power Supply	12
4.3 Block Diagram	13
5. Reliability Test	14
5.1 Test Item	14
5.2 Judgment Standard	15
6. Appearance Standards	16
6.1 Inspection Conditions	16
6.2 Definition of Applicable Zones	16
6.3 Standards	17
7. Handling and Precautions	19
8. Warranty:	20
9. Dimensional Outlines	21
10. Package information	22

Appendix : Inspection Standard



1. General Specifications

Operating Temperature	:	Min. -20°C ~ Max. 70°C
Storage Temperature	:	Min. -30°C ~ Max. 80°C
Dot Pixels	:	320 (W) x 240 (H) dots
Dot Size	:	0.34 (W) x 0.34 (H) mm
Dot Space	:	0.02 (W) x 0.02 (H) mm
Viewing Area	:	122.0 (W) x 92.0 (H) mm
Display Area	:	115.18(W)x 86.38(H) mm
Outline Dimensions	:	148.85* (W) x 120.24** (H) x 13 max.*** (D) mm
		** Without LED Cable
Weight	:	N/A
LCD Type	:	FSTN/ Positive / Transflective
Viewing Direction	:	6 O'clock
Data Transfer	:	8-bit parallel data transfer
Controller LSI	:	SAP3305
DC-DC	:	AIC 1652
Backlight	:	With White LED B/L



2. Electrical Specifications

2.1 Absolute Maximum Ratings

$V_{SS} = 0V$

Parameter	Symbol	Conditions	Min.	Max.	Units
Supply Voltage (Logic)	$V_{DD} - V_{SS}$	--	- 0.3	7.0	V
Supply Voltage (LCD Drive)	$V_{LCD} - V_{SS}$	--	0	35.0	V
Input Voltage	V_I	--	- 0.3	$V_{DD} + 0.3$	V

2.2 DC Characteristics

$T_a = 25^\circ C, V_{SS} = 0V$

Parameter	Symbol	Conditions	Min.	Typ.	Max.	Units
Supply Voltage (Logic)	$V_{DD} - V_{SS}$	--	3.0	3.3	3.6	V
Supply Voltage (LCD Drive)	$V_{DD} - V_{EE}$	--	12.0	--	32.0	V
	$V_{DD} - V_O$	Shown in 3.1				V
High Level (Input Voltage)	V_{IH}	--	$0.8 \times V_{DD}$	--	V_{DD}	V
Low Level (Input Voltage)	V_{IL}	--	V_{SS}	--	$0.2 \times V_{DD}$	V
High Level (Output Voltage)	V_{OH}	$I_{OH} = -0.5mA$	2.4	--	--	V
Supply Current	I_{DD}	$V_{DD} = 5.0V$	--	20	30	mA
	I_{EE}	$V_{DD} = 5.0V$	--	3.0	5.0	mA
Frame	f_F	Duty = 50%	32	64	128	Hz



2.3 AC Characteristics

2.3.1 8080 family interface timing

Ta=-20 to 75°C

Signal	Symbol	Parameter	V _{DD} = 4.5 to 5.5		V _{DD} = 2.7 to 4.5		Units	Condition
			Min.	Max.	Min.	Max.		
A0, CS	t _{AH8}	Address hold time	10	--	10	--	ns	CL=100pF
	t _{AW8}	Address setup time	0	--	0	--	ns	
WR, RD	t _{CYC8}	System cycle time	See note	--	See note	--	ns	
	t _{CC}	Strobe pulse width	120	--	150	--	ns	
DB0 to DB7	t _{DS8}	Data setup time	120	--	120	--	ns	
	t _{DH8}	Data hold time	5	--	5	--	ns	
	t _{ACC8}	RD access time	--	50	--	80	ns	
	t _{OH8}	Output disable time	10	50	10	55	ns	

Note: For memory control and system control commands:

$$t_{CYC8} = 2t_c + t_{CC} + t_{CEA} + 75 > t_{ACV} + 245$$

For all other commands:

$$t_{CYC8} = 2t_c + t_{CC} + 30$$

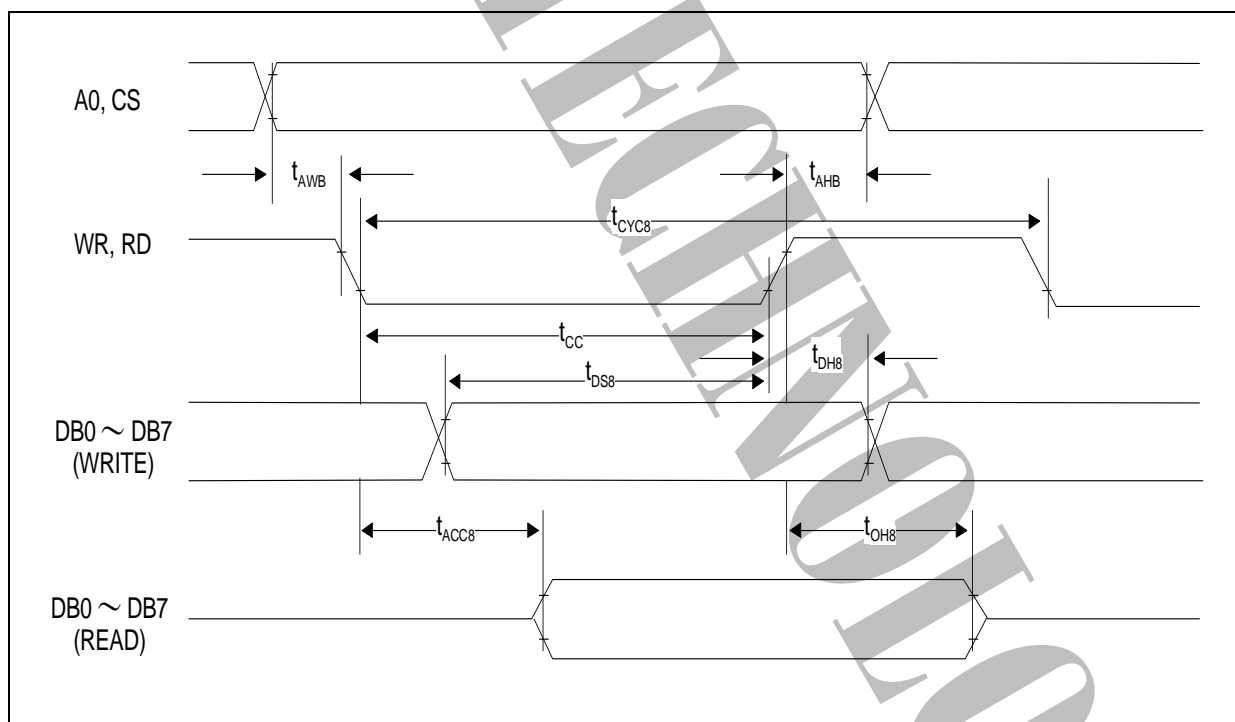



2.3.2 6800 family interface timing

Ta=-20 to 75°C

Signal	Symbol	Parameter	V _{DD} = 4.5 to 5.5		V _{DD} = 2.7 to 4.5		Units	Condition
			Min.	Max.	Min.	Max.		
A0, CS, R/W	t _{CYC6}	System cycle time	See note	--	See note	--	ns	CL=100pF
	t _{AW6}	Address setup time	0	--	10	--	ns	
	t _{AH6}	Address hold time	0	--	0	--	ns	
DB0 to DB7	t _{DS6}	Data setup time	100	--	120	--	ns	
	t _{DH6}	Data hold time	0	--	0	--	ns	
	t _{OH6}	Output disable time	10	50	10	75	ns	
	t _{ACC6}	Access time	--	85	--	130	ns	
WR, RD	t _{EW}	Enable pulse width	120	--	150	--	ns	

Note: For memory control and system control commands:

$$t_{CYC6} = 2t_c + t_{EW} + t_{CEA} + 75 > t_{ACV} + 245$$

For all other commands:

$$t_{CYC6} = 4t_c + t_{EW} + 30$$

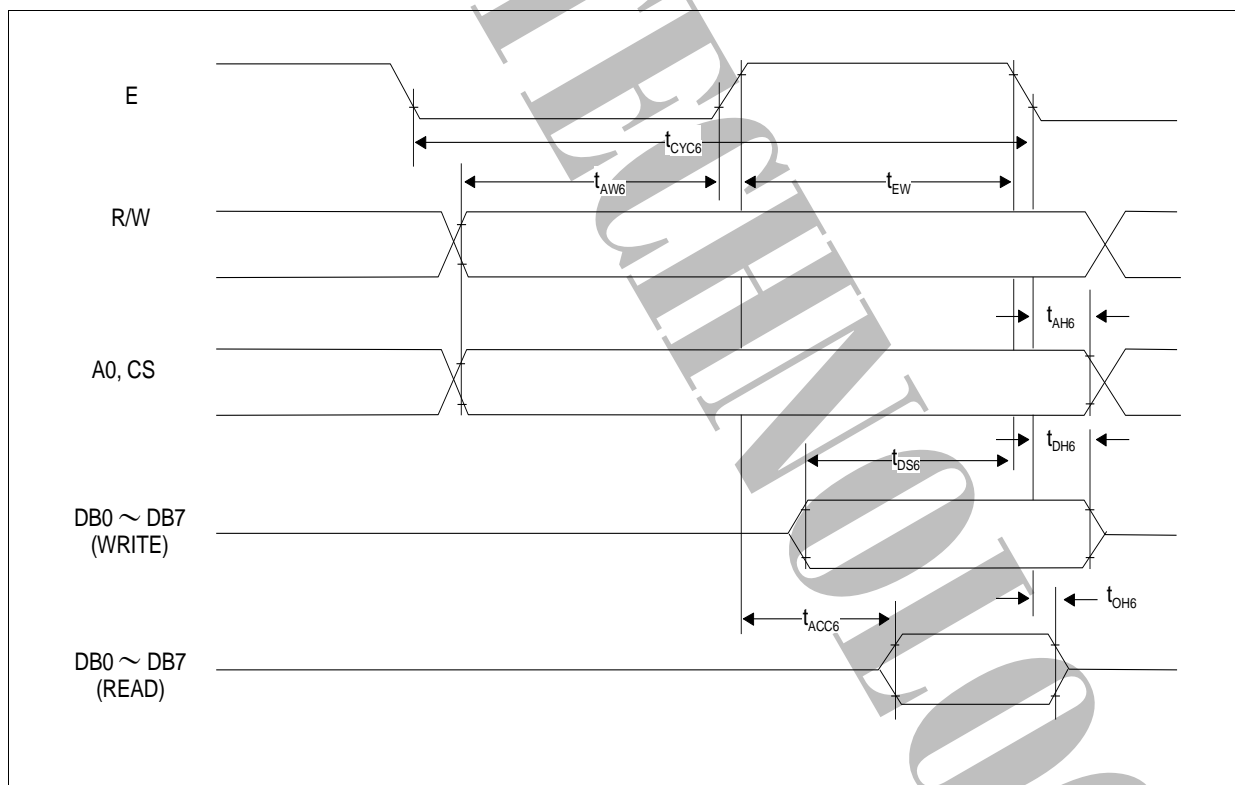

Note: JUMPER SETTING

80 family JUMP J80 Short

68 family JUMP J68 Short



2.4 Power Supply ON/OFF Sequence

2.4.1 ON Sequence

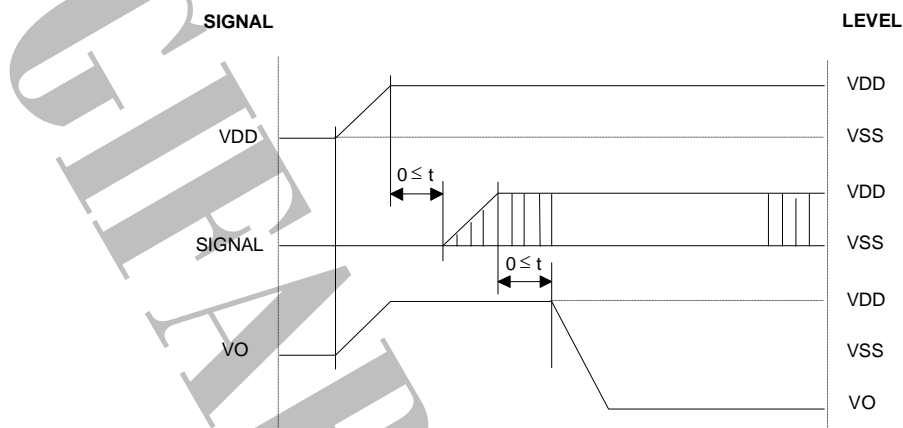

2.4.2 OFF Sequence

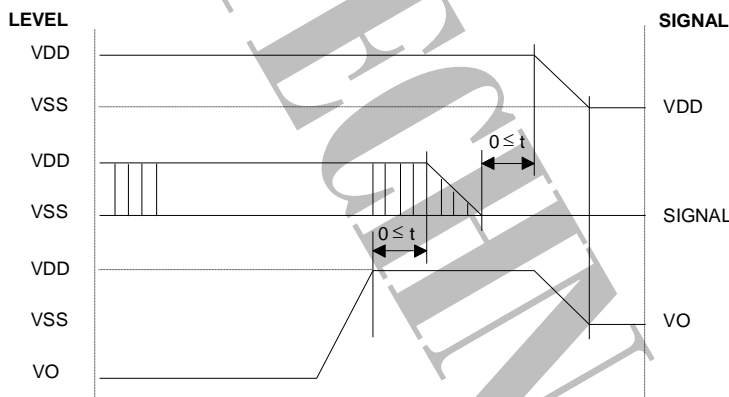

Please maintain the above sequence when turning on and off the power supply of the module. If V_{EE} is supplied to the module while internal alternate signal for LCD driving (M) is unstable or RESET is active, DC component will be supplied to the LCD panel. This may cause damage to the LCD module.



2.5 Spec. for LED back-light

2.5.1 Absolute Maximum Ratings

Parameter	Symbol	Conditions	Max	Units
Forward Current	I_F	--	260	mA
Reverse Voltage	V_R	--	5.0	V
LED Power Dissipation	P_D	--	0.884	W
Operation Temperature	T_{OPR}		-20 to 70	°C
Storage Temperature	T_{STG}		-40 to 80	°C

2.5.2 Operating Characteristics

$T_a = 25^\circ\text{C}$

Parameter	Symbol	Conditions	Min	Typ.	Max	Units
Forward Voltage*	V_F	$I_F=195\text{mA}$	3.0	3.3	3.4	V
Reverse Current	I_R	$V_R=5.0\text{V}$	--	--	0.3	mA
Luminance of Backlight Surface	L	$I_F=195\text{mA}$	400	--	--	cd/m ²
Uniformity**			75	80	--	%
AVG. x of 1931 C.I.E.	X		0.27	0.30	0.33	--
	Y	0.25	0.28	0.31	--	

*Measured between A,K (see the figure below)

**Uniformity = (Min./Max.) x 100%

2.5.3 Schematics Related

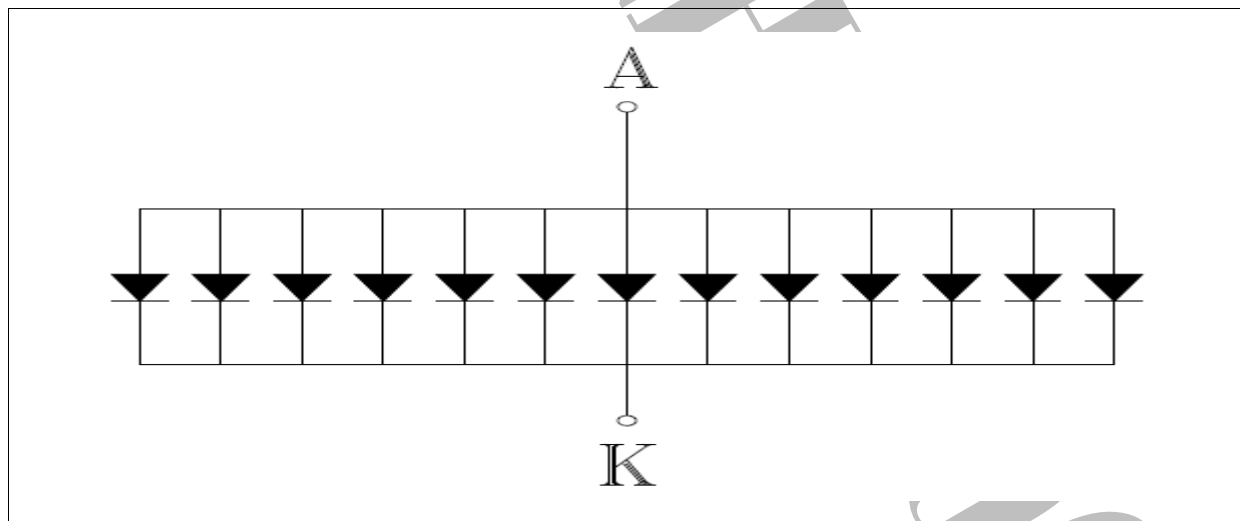



3. Optical Specifications

3.1 LCD Driving Voltage Recommended

Parameter	Symbol	Conditions	Min.	Typ.	Max.	Units
LCD Driving Voltage (Note 1)	$V_{DD}-V_O$	$T_a = -20\text{ }^\circ\text{C}$	24.7	25.2	25.7	V
		$T_a = 25\text{ }^\circ\text{C}$	20.8	21.2	21.6	V
		$T_a = 70\text{ }^\circ\text{C}$	19.5	20.0	20.5	V

Note 1 : Voltage (Applied actual waveform to LCD panel) for the best contrast. The range of minimum and maximum shows tolerance of the operating voltage. The specified contrast ratio and response time are not guaranteed over the entire range.

3.2 Optical Characteristics

$T_a=25\text{ }^\circ\text{C}$, 1/240 Duty, 1/13 Bias, $V_{DD} = 5.0\text{V}$ (Note 4)

Parameter	Symbol	Conditions	Min.	Typ.	Max.	Units
Contrast Ratio (Note 1)	CR	$T_a=25\text{ }^\circ\text{C}$	4	5.5	8	--
Viewing Angle (Shown in 3.3)	F-R	θ $T_a=25\text{ }^\circ\text{C}$	--	65	--	deg.
	R-L	ϕ $T_a=25\text{ }^\circ\text{C}$	--	-30 +30	--	deg.
Response Time	Rise (Note 2)	T_{ON} $T_a = 25\text{ }^\circ\text{C}$	100	120	180	msec
	Fall (Note 3)	T_{OFF} $T_a = 25\text{ }^\circ\text{C}$	110	140	210	msec

Note 1 : Contrast ratio is defined as follows.

$$CR = L_{OFF} / L_{ON}$$

L_{ON} : Luminance of the ON segments, L_{OFF} : Luminance of the OFF segments

Note 2 : The time that the luminance level reaches 90% of the saturation level from 0% when ON signal is applied.

Note 3 : The time that the luminance level reaches 10% of the saturation level from 100% when OFF signal is applied.

Note 4 : Definition of Driving Voltage V_D . Assuming that the typical driving waveforms shown below are applied to the LCD Panel at 1/A Duty - 1/B Bias (A : Duty Number, B : Bias Number). Driving voltage V_D is defined as follows: $V_D = (V_{th1}+V_{th2}) / 2$

V_{th1} : The voltage V_{O-P} that should provide 50% of the saturation level in the luminance at the segment which the ON signal is applied to.

V_{th2} : The voltage V_{O-P} that should provide 50% of the saturation level in the luminance at the segment which the OFF signal is applied to.

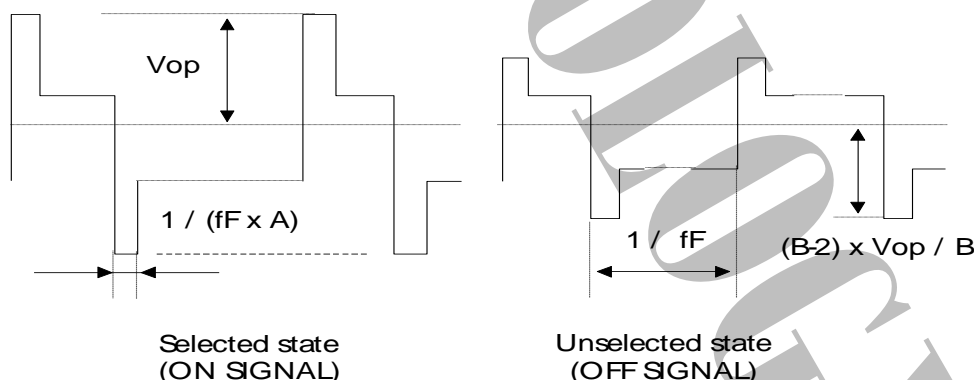



3.3 Definition of Viewing Angle

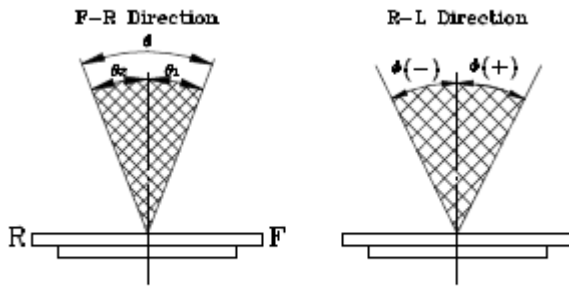

***Conditions**

Operating Voltage : V_{op}
 Frame Frequency : 70Hz
 Applying Waveform : 1/N duty 1/a bias
 Contrast Ratio : larger than 2

$$\theta = \theta_1 + \theta_2$$

3.4 Definition of Viewing Angle θ_F and θ_B

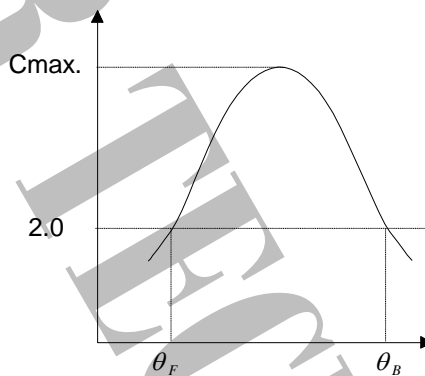

Viewing angles θ (ϕ fixed)

Optimum viewing angle with the naked eye and viewing angle θ at C_{max} .
 Above are not always the same.

3.5 Definition of Contrast Ratio(Cr)

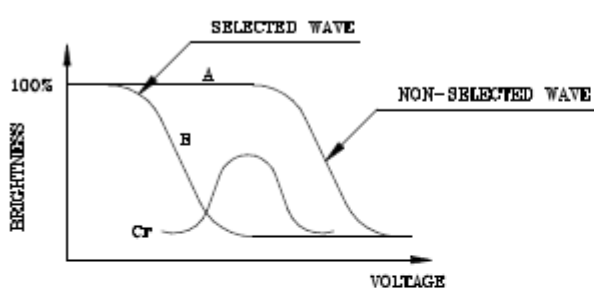

(positive type)

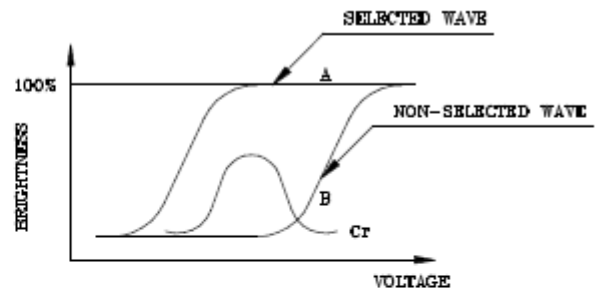

(negative type)

$$\text{Contrast Ratio : } Cr = A/B$$

***Conditions**

Operating Voltage : V_{op}
 Temperature : 25°C
 Viewing Angle (θ, ϕ) : (0,0)
 Frame Frequency : 70Hz
 Applying Waveform : 1/N duty 1/a bias



4. I/O Terminal

4.1 Pin Assignment

Pin No.	Symbol	Level	Function
1	V _{SS}	--	Power supply (0V, GND)
2	V _{DD}	--	Power supply for logic
3	V _o	--	Voltage level for LCD contrast adjustment
4	/RD	H/L	VRAM read signal, 8080 family : Read signal 6800 family : Enable clock
5	/WR	H/L	VRAM write signal, 8080 family : Write signal 6800 family : R/W signal
6	A0	H/L	VRAM address bus
7~14	DB0~DB7	H/L	Display data
15	/CS	H/L	Chip Select, This active-LOW input enables the RA8835. It is usually connected to the output of an address decoder device that maps the RA8835 into the memory space of the controlling microprocessor.
16	/RST (/RES)	H/L	Reset, This active-LOW input performs hardware reset on the RA8835. It is a Schmitt-trigger input for enhanced noise immunity; however, care should be taken to ensure that it is not triggered if the supply voltage is lowered.
17	V _{EE}	--	Power Supply for LCD Drive
18	FGND	--	Frame Ground
19	NC	--	No Connection
20	NC	--	No Connection

4.2 Example of Power Supply

It is recommended to apply a potentiometer for the contrast adjust due to the tolerance of the driving voltage and its temperature dependence.

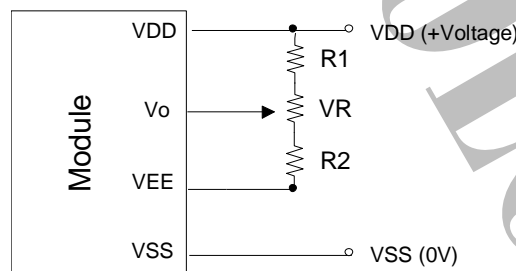

$$R1 + R2 + VR = 10 \sim 20K\Omega$$



4.3 Block Diagram

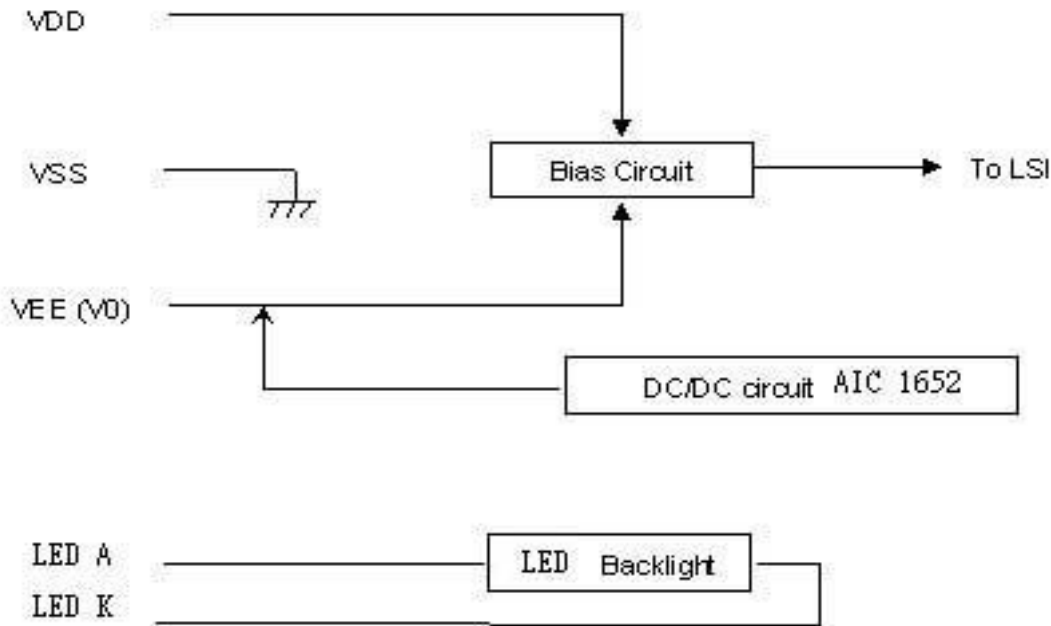
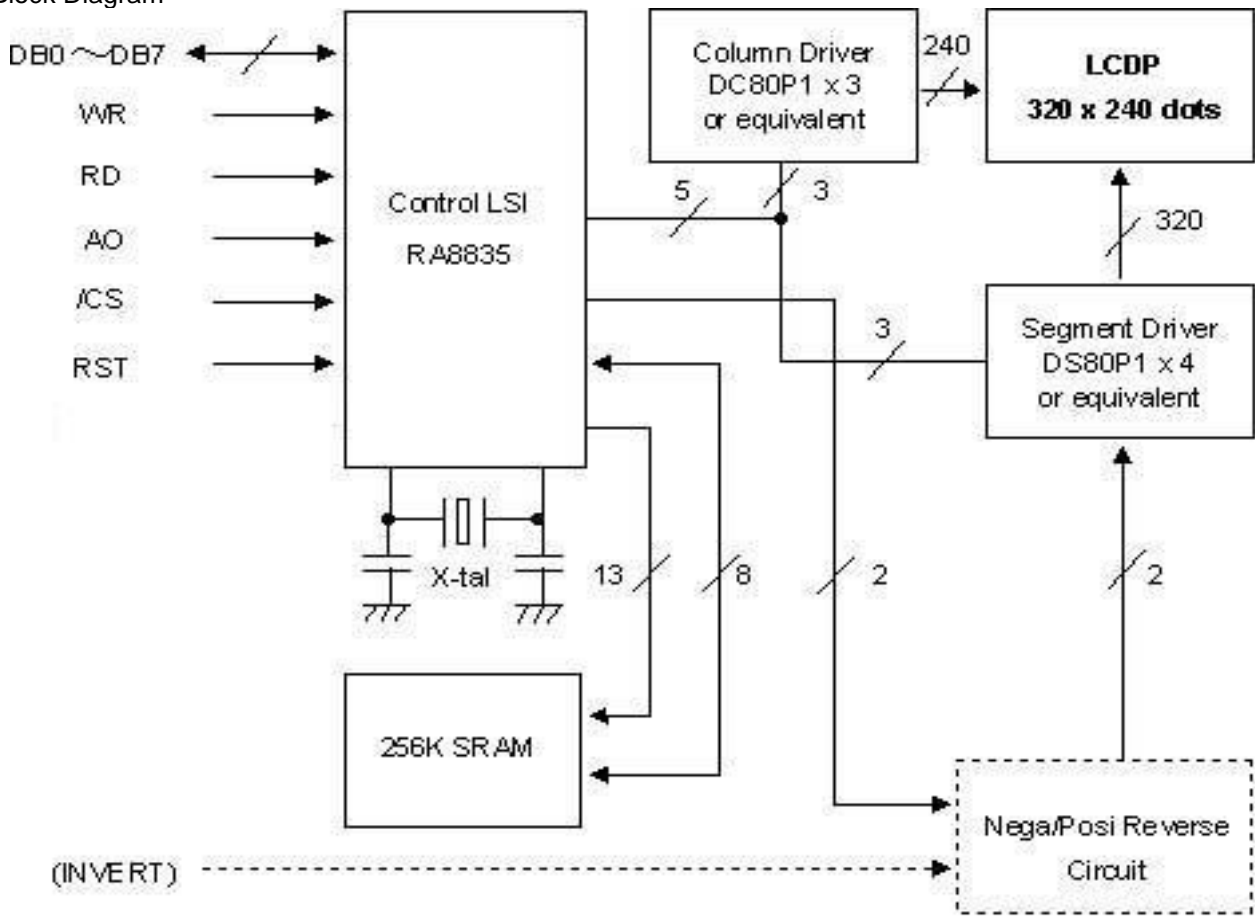



5. Reliability Test

5.1 Test Item

No change on display and in operation under the following test condition.

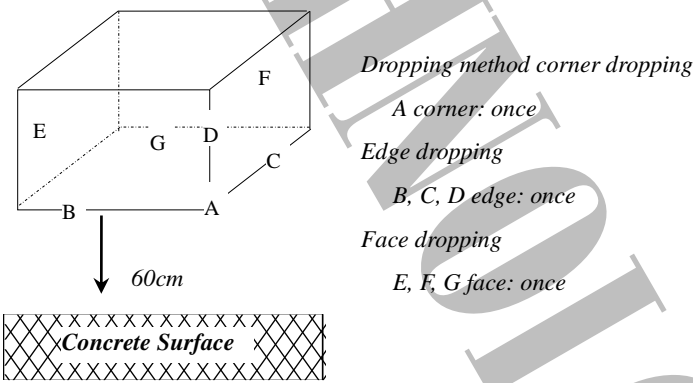
No.	Test Item	Description	Condition	Note
1.	High Temperature (Operation)	Durability test under long time high temperature with electrical stress (voltage, current)	70°C ± 2°C 96hrs	
2.	High Temperature (Storage)	Durability test under long time high temperature storage	80°C ± 2°C 96hrs	4
3.	Low Temperature (Operation)	Durability test under long time low temperature with electrical stress (voltage, current)	-20°C ± 2°C, 96hrs	3
4.	Low Temperature (Storage)	Durability test under long time low temperature storage	-30°C ± 2°C, 96hrs	3, 4
5.	Damp Proof Test	Durability test under long time high temperature and high humidity	40°C± 2°C, 90~95% RH 96hrs	3, 4
6.	Vibration Test	Total fixed amplitude: 1.5mm Vibration frequency: 10~55Hz One cycle 60 seconds to 3 directions of X, Y, Z for each 15 minutes	--	5
7.	Drop Test	To be measured after dropping from 60cm high on the concrete surface in packing state. 		

Note 1: Unless otherwise specified, tests will be conducted under the following condition,
Temperature : 25°C ± 2°C
Humidity : 65% ± 5%

Note 2: Unless otherwise specified, tests will be not conducted under functioning state.

Note 3: No dew condensation to be observed.

Note 4: The function test shall be conducted after 4 hours storage at the normal temperature and humidity after removed from the test chamber.

Note 5: Vibration test will be conducted to the product itself without putting it in a container.



5.2 Judgment Standard

Failure Mode	Test Item							Judgment Standard
	1	2	3	4	5	6	7	
Orientation	*	*	*	*	*			No remarkable degradation of appearance under bias/ non-bias condition
Current Value (IAC)	*	*	*	*	*			No remarkable increase
Contrast	*		*	*	*			No remarkable poor contrast
Domain	*	*	*	*	*			Less than 20% of all dots have reverse tilt of more than on third of one dot area.
Bubble (Inside Cell)	*	*	*	*	*	*		As per "Appearance Standard" (Note. Including one which disappear after 25°C 2H)
Polarizer	*				*	*		As per "Appearance Standard" no remarkable appearance change
Glass Damage							*	As per "Appearance Standard"

- Note.1. * is strong linkage between Failure Mode and Test Item.
 2. Number of Test Item should be referred to former page.
 3. Judgment and Standard value should be fixed by other inspection standard and criteria samples.



6. Appearance Standards

6.1 Inspection Conditions

The LCD shall be inspected under 40W white fluorescent light. The distance between the eyes and the sample shall be more than 30cm. All directions for inspecting the sample should be within 45° against perpendicular line.

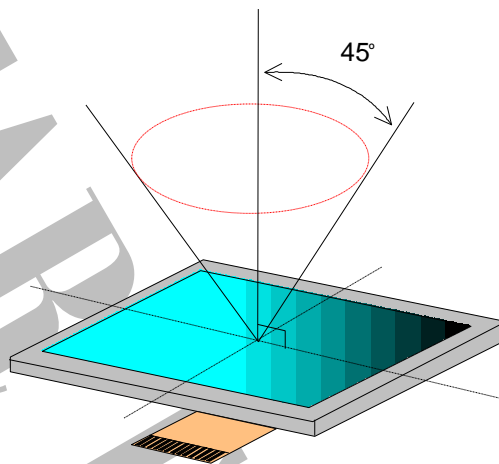

6.2 Definition of Applicable Zones

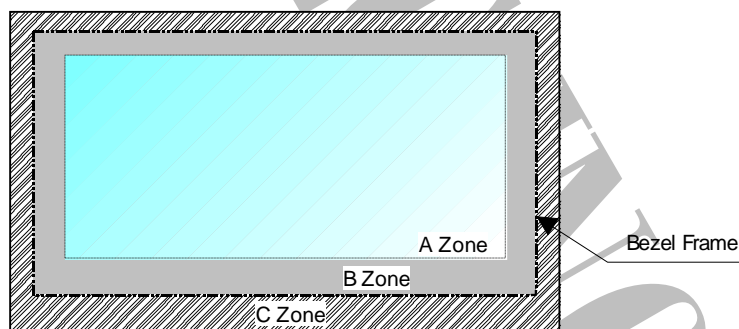

A Zone : Active display area

B Zone : Area from outside of "A Zone" to validity viewing area

C Zone : Rest parts

A Zone + B Zone = Validity viewing area



6.3 Standards

No.	Parameter	Criteria																																					
1.	Black and White Spots, Foreign Substances	(1) Round Shape <table border="1"> <thead> <tr> <th rowspan="2">Dimension (mm)</th> <th rowspan="2">Zone</th> <th colspan="3">Acceptable Number</th> </tr> <tr> <th>A</th> <th>B</th> <th>C</th> </tr> </thead> <tbody> <tr> <td>D ≤ 0.2</td> <td></td> <td>*</td> <td>*</td> <td>*</td> </tr> <tr> <td>0.2 < D ≤ 0.3</td> <td></td> <td>3</td> <td>5</td> <td>*</td> </tr> <tr> <td>0.3 < D ≤ 0.4</td> <td></td> <td>2</td> <td>3</td> <td>*</td> </tr> <tr> <td>0.4 < D ≤ 0.5</td> <td></td> <td>0</td> <td>1</td> <td>*</td> </tr> <tr> <td>0.5 < D</td> <td></td> <td>0</td> <td>0</td> <td>*</td> </tr> </tbody> </table> <p>D = (Long + Short)/2 * : Disregard</p>	Dimension (mm)	Zone	Acceptable Number			A	B	C	D ≤ 0.2		*	*	*	0.2 < D ≤ 0.3		3	5	*	0.3 < D ≤ 0.4		2	3	*	0.4 < D ≤ 0.5		0	1	*	0.5 < D		0	0	*				
		Dimension (mm)			Zone	Acceptable Number																																	
A	B		C																																				
D ≤ 0.2		*	*	*																																			
0.2 < D ≤ 0.3		3	5	*																																			
0.3 < D ≤ 0.4		2	3	*																																			
0.4 < D ≤ 0.5		0	1	*																																			
0.5 < D		0	0	*																																			
		(2) Line Shape <table border="1"> <thead> <tr> <th rowspan="2">X (mm)</th> <th rowspan="2">Y (mm)</th> <th rowspan="2">Zone</th> <th rowspan="2">Zone</th> <th colspan="3">Acceptable Number</th> </tr> <tr> <th>A</th> <th>B</th> <th>C</th> </tr> </thead> <tbody> <tr> <td>--</td> <td>0.03 ≥ W</td> <td></td> <td></td> <td>*</td> <td>*</td> <td>*</td> </tr> <tr> <td>2.0 ≥ L</td> <td>0.05 ≥ W</td> <td></td> <td></td> <td>3</td> <td>3</td> <td>*</td> </tr> <tr> <td>1.0 ≥ L</td> <td>0.1 ≥ W</td> <td></td> <td></td> <td>3</td> <td>3</td> <td>*</td> </tr> <tr> <td>--</td> <td>0.1 < W</td> <td colspan="4">In the same way (1)</td> </tr> </tbody> </table> <p>X : Length Y: Width * : Disregard Total defects shall not exceed 5.</p>	X (mm)	Y (mm)	Zone	Zone	Acceptable Number			A	B	C	--	0.03 ≥ W			*	*	*	2.0 ≥ L	0.05 ≥ W			3	3	*	1.0 ≥ L	0.1 ≥ W			3	3	*	--	0.1 < W	In the same way (1)			
X (mm)	Y (mm)	Zone					Zone	Acceptable Number																															
			A	B	C																																		
--	0.03 ≥ W			*	*	*																																	
2.0 ≥ L	0.05 ≥ W			3	3	*																																	
1.0 ≥ L	0.1 ≥ W			3	3	*																																	
--	0.1 < W	In the same way (1)																																					
2.	Air Bubbles (between glass & polarizer)	<table border="1"> <thead> <tr> <th rowspan="2">Dimension (mm)</th> <th rowspan="2">Zone</th> <th colspan="3">Acceptable Number</th> </tr> <tr> <th>A</th> <th>B</th> <th>C</th> </tr> </thead> <tbody> <tr> <td>D ≤ 0.3</td> <td></td> <td>*</td> <td>*</td> <td>*</td> </tr> <tr> <td>0.3 < D ≤ 0.4</td> <td></td> <td>3</td> <td>*</td> <td>*</td> </tr> <tr> <td>0.4 < D ≤ 0.6</td> <td></td> <td>2</td> <td>3</td> <td>*</td> </tr> <tr> <td>0.6 < D</td> <td></td> <td>0</td> <td>0</td> <td>*</td> </tr> </tbody> </table> <p>*: Disregard Total defects shall not exceed 3.</p>	Dimension (mm)	Zone	Acceptable Number			A	B	C	D ≤ 0.3		*	*	*	0.3 < D ≤ 0.4		3	*	*	0.4 < D ≤ 0.6		2	3	*	0.6 < D		0	0	*									
Dimension (mm)	Zone	Acceptable Number																																					
		A	B	C																																			
D ≤ 0.3		*	*	*																																			
0.3 < D ≤ 0.4		3	*	*																																			
0.4 < D ≤ 0.6		2	3	*																																			
0.6 < D		0	0	*																																			

To be continued.....

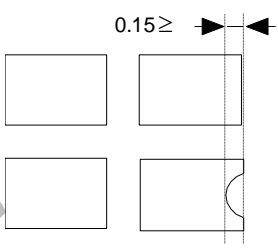
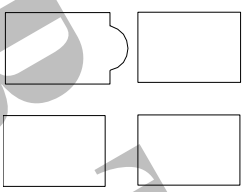
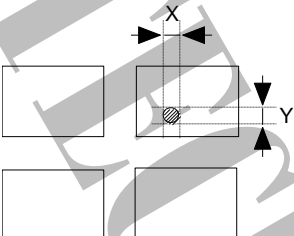
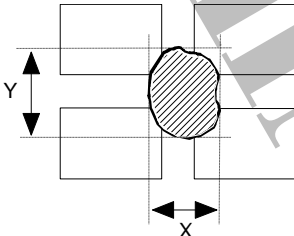

No.	Parameter	Criteria
3.	The Shape of Dot	<p>(1) Dot Shape (with Dent)</p>  <p>As per the sketch of left hand.</p> <p>(2) Dot Shape (with Projection)</p>  <p>Should not be connected to next dot.</p> <p>(3) Pin Hole</p>  <p>$(X+Y)/2 \leq 0.2\text{mm}$ (Less than 0.1mm is not counted.)</p> <p>(4) Deformation</p>  <p>$(X+Y)/2 \leq 0.2\text{mm}$</p> <p>Total acceptable number: 1/dot, 5/cell (Defect number of (4): 1pc.)</p>
4.	Polarizer Scratches	Not to be conspicuous defects.
5.	Polarizer Dirts	If the stains are removed easily from LCDP surface, the module is not defective.
6.	Complex Foreign Substance Defects	Black spots, line shaped foreign substance or air bubbles between glass & polarizer should be 5pcs maximum in total.
7.	Distance between different Foreign Substance defects	$D \leq 0.2$: 20mm or more $0.2 < D$: 40mm or more



7. Handling and Precautions

The Following precautions will guide you in handling our product correctly.

- 1 Liquid crystal display devices
 - 1.1 The liquid crystal display device panel used in the liquid crystal display module is made of plate glass. Avoid any strong mechanical shock. Should the glass break handle it with care.
 - 1.2 The polarizer adhering to the surface of the LCD is made of a soft material. Guard against scratching it.
- 2 Care of the liquid crystal display module against static electricity discharge.
 - 2.1 When working with the module, be sure to ground your body and any electrical equipment you may be using. We strongly recommend the use of anti static mats (made of rubber), to protect work tables against the hazards of electrical shock.
 - 2.2 Avoid the use of work clothing made of synthetic fibers. We recommend cotton clothing or other conductivity-treated fibers.
 - 2.3 Slowly and carefully remove the protective film from the LCD module, since this operation can generate static electricity.
- 3 When the LCD module alone must be stored for long periods of time:
 - 3.1 Protect the modules from high temperature and humidity.
 - 3.2 Keep the modules out of direct sunlight or direct exposure to ultra-violet rays.
 - 3.3 Protect the modules from excessive external forces.
- 4 Use the module with a power supply that is equipped with an over current protector circuit, since the module is not provided with this protective feature.
- 5 Do not ingest the LCD fluid itself should it leak out of a damaged LCD module. Should hands or clothing come in contact with LCD fluid, wash immediately with soap.
- 6 Conductivity is not guaranteed for models that use metal holders where solder connections between the metal holder and the PCB are not used. Please contact us to discuss appropriate ways to assure conductivity.



8. Warranty:

This product has been manufactured to your company's specifications as a part for use in your company's general electronic products. It is guaranteed to perform according to delivery specifications. For any other use apart from general electronic equipment, we cannot take responsibility if the product is used in medical devices, nuclear power control equipment, aerospace equipment, fire and security systems, or any other applications in which there is a direct risk to human life and where extremely high levels of reliability are required. If the product is to be used in any of the above applications, we will need to enter into a separate product liability agreement.

- 1 We cannot accept responsibility for any defect, which may arise from additional manufacturing of the product (including disassembly and reassembly), after product delivery.
- 2 We cannot accept responsibility for any defect, which may arise after the application of strong external force to the product.
- 3 We cannot accept responsibility for any defect, which may arise due to the application of static electricity after the product has passed your company's acceptance inspection procedures.
- 4 We cannot accept responsibility for industrial property, which may arise through the use of your product, with exception to those issues relating directly to the structure or method of manufacturing of our product.



9. Dimensional Outlines

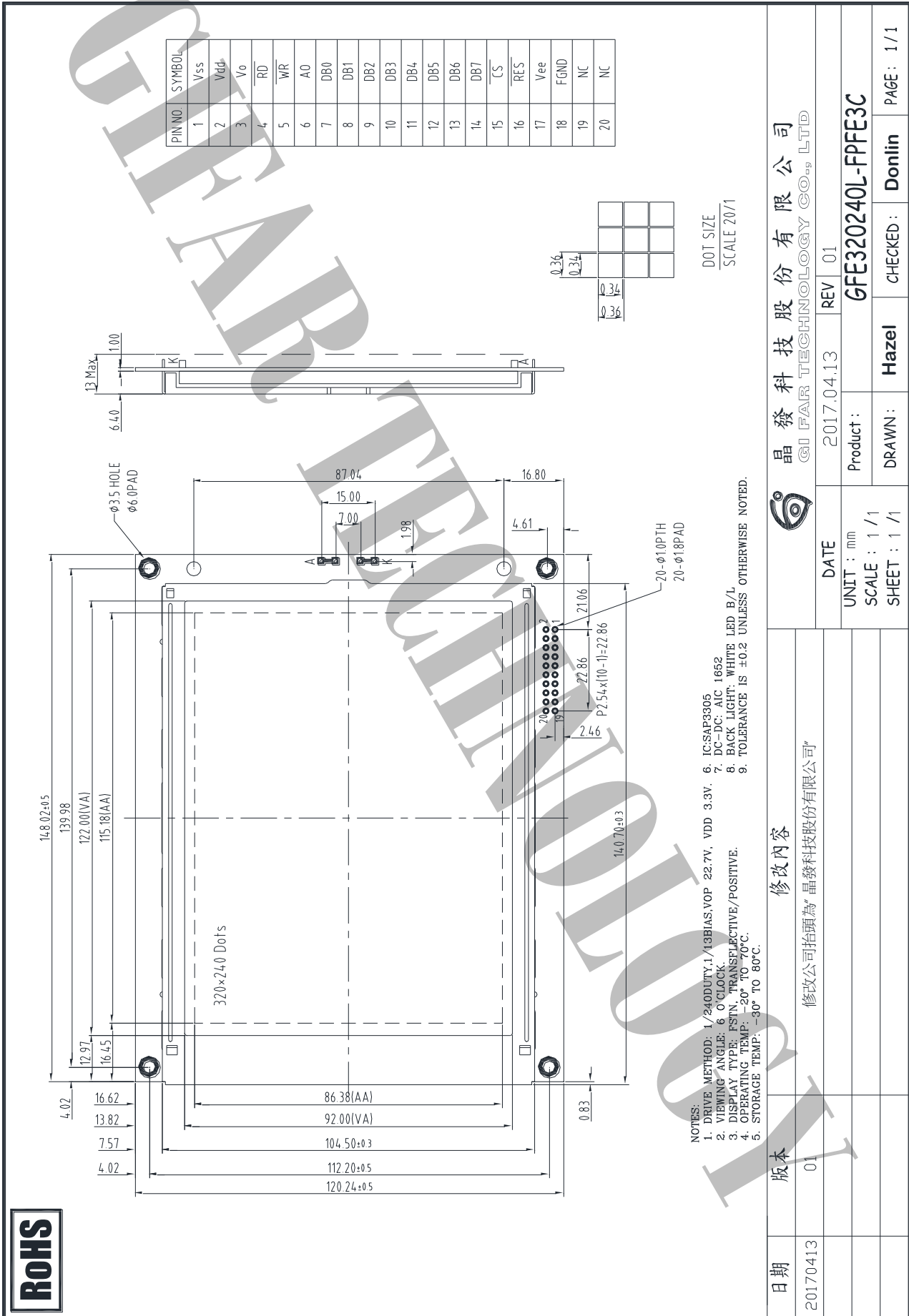



10. PACKAGE INFORMATION

1	1 bubble bag	:	1 pcs (modules)
2	1 box	:	22 bubble bag +1 set carboard
3	Total pcs	:	1 Carton (22 bubble bag + 1 set carboard) = 22 pcs
4	Carton size = NO. 12	:	460*260*180mm
5	Net weight	:	3.9 KG
6	Gross weight	:	5.0 KG

** Illustration

- 1 bubble bag = 1 pcs (modules)



- 1 box = 22 bubble bag +1 set carboard



出貨檢驗標準書
Shipping inspection standard

核准 Approved by	審核 Checked by	作成 Made by
ANDY	JACKY	RUBY

1.目的 Purpose :

規範出貨產品之檢驗項目及判斷標準，確保產品出貨能滿足客戶要求。

Standardize the inspection items and judgment standards to ensure the products that shipped out can meet customer's requirements.

2.範圍 Area :

適用於出廠之所有產品。

Applicable to all products shipped from the factory.

3.名詞解釋 Explanation of terms :

3-1 主要缺陷：亦會造成功能缺失或嚴重外觀缺陷。

Major Defects: It also causes loss of function or serious appearance defects.

3-2 次要缺陷：稍有缺陷但不影響客戶使用。

Minor defect: Slightly defective but does not affect customer use.

4.檢驗體制 Inspection system :

4-1 抽樣計劃：依 ANSI/ASQ Z1.4 一般檢驗水準 II 之 正常檢驗一次抽驗方案。

Sampling plan: According to ANSI/ASQ Z1.4 general inspection level II the normal inspection one-time sampling plan.

4-2 允收水準 Acceptable Level : (AQL)

主要缺陷 Major defect : 0.4 %

次要缺陷 Minor defect : 0.65 %

5.檢驗條件 Inspection conditions :

5-1 使用相關之檢測儀器及測試、量測工具。

Use relevant testing instrument, testing and measuring tools .

5-2 環境要求：其條件需控制在常溫下 $23^{\circ}\text{C}\pm 3^{\circ}\text{C}$ 及溼度 70%RH 以下。

Environmental requirements: The conditions should be controlled at room temperature $23^{\circ}\text{C}\pm 3^{\circ}\text{C}$ and humidity below 70%RH.

5-3 外觀檢驗：須在 $380\pm 20\%$ LUX 的白色日光燈下，其目視距離需於產品離 30 ± 5 cm 檢驗。

Appearance inspection: Under the white fluorescent lamp of $380\pm 20\%$ LUX , the visual distance shall be checked above the product 30 ± 5 cm.

5-4 電性測試 Electrical Testing :

5-4-1 有背光之產品需關燈並在 $5\sim 300\text{Lux}\pm 3\%$ 下檢驗。

The products with backlight should be tested at $5\sim 300\pm 3\%$ Lux.

5-4-2 無背光之產品需開燈並在 $60\sim 300\text{Lux}\pm 3\%$ 白色日光燈下檢驗。

Products without backlight need to be turned on and tested under $60\sim 300 \pm 3\%$ LUX white fluorescent lamps .

5-5 檢查視角依產品視角方向。

Check the viewing angle according to the product viewing angle.

5-6 其不良現象檢視區域 Bad phenomenon View area

5-6-1 適用種類 Applicable category : COB、TFT

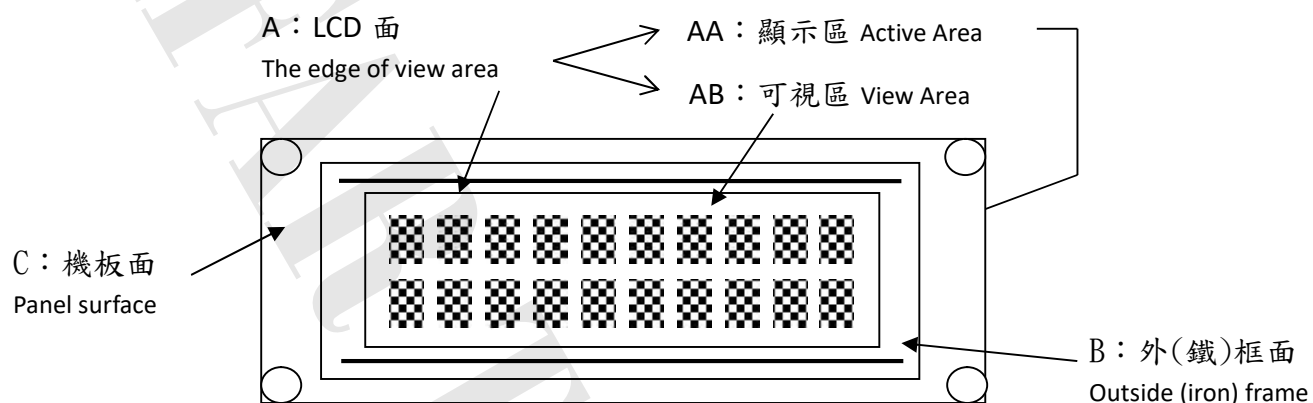

5-6-2 適用種類 Applicable category : COG、TAB、TN

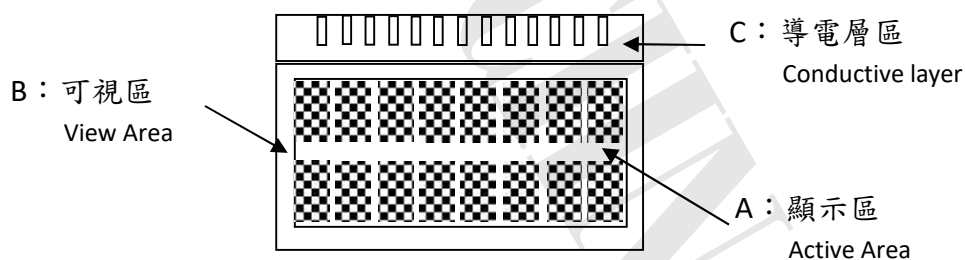

6. 檢驗標準 Inspection standards

COB

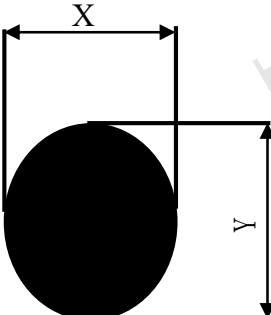
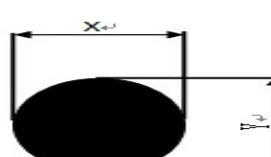
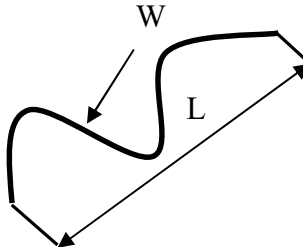
種類 Category		COB																			
編號 No.	檢驗項目 Item	檢驗內容及判定標準 Inspection Content & Standard	區域 Zone	類別 Category	缺陷等級 Level																
1	點類(一) Dot (1)	黑點、刺傷...等圓狀 Black dot、Stab...and other round shape $\varphi = \frac{(X + Y)}{2}$ 	兩點距離須超過 5 mm Two points have to be ≥ 5 mm <table border="1"> <thead> <tr> <th>φ (mm)</th> <th>允收數 Acceptance Qty</th> </tr> </thead> <tbody> <tr> <td>$\phi \leq 0.1$</td> <td>無視 Ignore</td> </tr> <tr> <td>$0.1 < \phi \leq 0.25$</td> <td>3</td> </tr> <tr> <td>$0.25 < \phi \leq 0.3$</td> <td>1</td> </tr> <tr> <td>$\phi > 0.3$</td> <td>0</td> </tr> </tbody> </table>	φ (mm)	允收數 Acceptance Qty	$\phi \leq 0.1$	無視 Ignore	$0.1 < \phi \leq 0.25$	3	$0.25 < \phi \leq 0.3$	1	$\phi > 0.3$	0	A	外觀 Appearance	次要 Minor AQL0.65%					
		φ (mm)	允收數 Acceptance Qty																		
$\phi \leq 0.1$	無視 Ignore																				
$0.1 < \phi \leq 0.25$	3																				
$0.25 < \phi \leq 0.3$	1																				
$\phi > 0.3$	0																				
		其點位於側邊 無視 The dot is located on the side(B area)-OK <table border="1"> <thead> <tr> <th>φ (mm)</th> <th>允收數 Acceptance Qty</th> </tr> </thead> <tbody> <tr> <td>$\phi \leq 0.3$</td> <td>無視 Ignore</td> </tr> <tr> <td>$0.3 < \phi \leq 0.5$</td> <td>3</td> </tr> <tr> <td>$0.5 < \phi \leq 1$</td> <td>1</td> </tr> <tr> <td>$\phi > 1$</td> <td>0</td> </tr> </tbody> </table>	φ (mm)	允收數 Acceptance Qty	$\phi \leq 0.3$	無視 Ignore	$0.3 < \phi \leq 0.5$	3	$0.5 < \phi \leq 1$	1	$\phi > 1$	0	B	外觀 Appearance	次要 Minor AQL0.65%						
φ (mm)	允收數 Acceptance Qty																				
$\phi \leq 0.3$	無視 Ignore																				
$0.3 < \phi \leq 0.5$	3																				
$0.5 < \phi \leq 1$	1																				
$\phi > 1$	0																				
2	點類(二) Dot (2)	氣泡、凹凸點 Bubble、Uneven dots $\varphi = \frac{(X + Y)}{2}$ 	兩點距離須超過 5 mm Two points to be ≥ 5 mm <table border="1"> <thead> <tr> <th>φ (mm)</th> <th>允收數 Acceptance Qty</th> </tr> </thead> <tbody> <tr> <td>$\phi \leq 0.2$</td> <td>無視 Ignore</td> </tr> <tr> <td>$0.2 < \phi \leq 0.5$</td> <td>2</td> </tr> <tr> <td>$\phi > 0.5$</td> <td>0</td> </tr> </tbody> </table>	φ (mm)	允收數 Acceptance Qty	$\phi \leq 0.2$	無視 Ignore	$0.2 < \phi \leq 0.5$	2	$\phi > 0.5$	0	A	外觀 Appearance	次要 Minor AQL0.65%							
φ (mm)	允收數 Acceptance Qty																				
$\phi \leq 0.2$	無視 Ignore																				
$0.2 < \phi \leq 0.5$	2																				
$\phi > 0.5$	0																				
3	線類 Line	刮傷、毛屑...等線狀 Scratch、Fiber.. and other linear shape. 	<table border="1"> <thead> <tr> <th>L (mm)</th> <th>W (mm)</th> <th>允收數 Acceptance Qty</th> </tr> </thead> <tbody> <tr> <td>--</td> <td>$W \leq 0.02$</td> <td>無視 Ignore</td> </tr> <tr> <td>$L \leq 5$</td> <td>$W \leq 0.03$</td> <td>3</td> </tr> <tr> <td>$L \leq 3$</td> <td>$W \leq 0.05$</td> <td>2</td> </tr> <tr> <td>$L > 5$</td> <td>$W > 0.05$</td> <td>0</td> </tr> </tbody> </table>	L (mm)	W (mm)	允收數 Acceptance Qty	--	$W \leq 0.02$	無視 Ignore	$L \leq 5$	$W \leq 0.03$	3	$L \leq 3$	$W \leq 0.05$	2	$L > 5$	$W > 0.05$	0	A	外觀 Appearance	次要 Minor AQL0.65%
L (mm)	W (mm)	允收數 Acceptance Qty																			
--	$W \leq 0.02$	無視 Ignore																			
$L \leq 5$	$W \leq 0.03$	3																			
$L \leq 3$	$W \leq 0.05$	2																			
$L > 5$	$W > 0.05$	0																			
4	底色 Background color	同批供貨不能有明顯色差 No obvious color difference allowed in same shipment. (必要時與客端制定限度樣) (According to the gold samples if necessary)	A	外觀 Appearance	次要 Minor AQL0.65%																

5	零件位置 Parts position	與工程 BOM 上標示不符 拒收 Different with the BOM marked Reject	C	外觀 Appearance	主要 Major AQL 0.4%
6	板面潔淨 FPC/PCB's surface is clean	※ 焊接面上附著錫渣、珠 拒收 Solder side has tin slag, beads or particle Reject ※ 焊接面上附著於過多錫油 拒收 Solder side has too much tin oil Reject	C	外觀 Appearance	次要 Minor AQL0.65%
7	點、線類 (三) Dot、Line (3)	※ 於全黑、白畫面下看見之區塊狀或線狀不良 拒收 There is a block or linear in the view area under the screen is whole black or white. Reject ※ 但依 2% ND Filter 遮蓋無視 允收 But after inspecting by 2% ND Filter without seeing block or linear, it is confirmed Acceptance	AA	電訊 Electronics	次要 Minor AQL0.65%
8	點、線類 (四) Dot、Line (4)	畫面中顯示出現黑、白、亮、異色點或線狀 There is a black, white, bright or other dot or lines showing in the view area. ※ 依編號 1、3 之判定標準 According to the inspection standard: No. 1 and 3.	AA	電訊 Electronics	次要 Minor AQL0.65%
9	缺字 Lack of characters	顯示時畫面缺少部份字元 拒收 Lacking part of characters in the view area. Reject	AA	電訊 Electronics	主要 Major AQL 0.4%
10	無動作 No reaction	顯示畫面一直處於起始畫面而無法進行切換 拒收 The display (view area) always shows in the initial screen and can't be switched to others. Reject	AA	電訊 Electronics	主要 Major AQL 0.4%
11	無畫面 No display	通電後，完全無任何畫面顯示 拒收 After connecting to the power, there is no display. Reject	AA	電訊 Electronics	主要 Major AQL 0.4%
12	斷線 Broken line	顯示畫面中少直、橫線 拒收 There is a lack of vertical or horizontal lines in the view area. Reject	AA	電訊 Electronics	主要 Major AQL 0.4%
13	CROSS TALK	顯示畫面時有局部之條紋或拖影 There are some stripes or shadow/smear showing in the view area. 拒收或與客端簽訂限度樣 Reject or inspect according to the golden sample	AA	電訊 Electronics	次要 Minor AQL0.65%

14	I CON	顯示畫面缺少部份顯示圖案 拒收 Lack of partial ICON in the view area. Reject	AA	電訊 Electronics	主要 Major AQL 0.4%
15	深淺不一 Color difference	顯示畫面的對比，比其他顯示深或淺並依電氣規格(VOP) 值判定 The contrast of display is obviously lighter or darker than others and according to the VOP value in the electronics specification. 拒收或與客端簽訂限度樣 Reject or inspect according to the golden sample	AA	電訊 Electronics	次要 Minor AQL0.65%
16	畫面異常 Abnormal screen	通電後畫面出現未定義之電訊不良現象 拒收 After connecting to the power, there is an undefined electronics appearance showing in the view area. Reject	AA	電訊 Electronics	主要 Major AQL 0.4%
17	背光色不均 Uneven color of backlight	※ 點亮後 LED 有明暗不均現象依其均勻度判定 拒收 After lighting LEDs have brightness and darkness uneven the determined according to its uniformity. Reject ※ 點亮後 LED 色澤不一致 拒收 LED color is inconsistent after lighting Reject	A	電訊 Electronics	次要 Minor AQL0.65%
18	亮度不足 Lack of brightness	波長、色座標、輝度與圖面標示定義不符 拒收 Wave length, chromatic coordinates, brightness don't correspond to the definition of the drawing. Reject	A	電訊 Electronics	次要 Minor AQL0.65%
19	尺寸量測 Size Measurement	未依圖面上標示 拒收 No correspond to the indication on the drawing. Reject	ALL	外觀 Appearance	主要 Major AQL 0.4%
20	其他 Other	如發現有上述未定義之不良則與客端簽訂限度樣 If there is another undefined defective situation. It will be listed as others. The inspection standard is according to the golden sample.	ALL	電訊 Electronics 外觀 Appearance	次要 Minor AQL0.65%