





SPECIFICATIONS

CUSTOMER : _____
MODEL NO. : **GFC2002P-BNFEJSB04**
VERSION : **E**
DATE : **2023.11.07**
CERTIFICATION : **ROHS**

Customer Sign	Approved By	Prepared By	Prepared By
			

晶發科技股份有限公司
GI FAR TECHNOLOGY CO.,LTD.

新北市樹林區東豐街 81 號

No. 81, Dongfeng St, Shulin District, 238034, New Taipei City, Taiwan, R.O.C.

TEL: +886-2-8684-1188 FAX: +886-2-8684-8532



Revision Record

Data(y/m/d)	Ver.	Description	Note	page
2014.09.22	A	Specification released		
2015.01.12	B	拿掉 D1 LED		21
2015.11.17	C	增加包裝資料		20
2016.12.29	D	修改公司抬頭、格式統一		
2023.11.07	E	更新公司抬頭認證圖示		



CONTENTS

1.	Scope	-----	4
2.	Product Specifications	-----	4
2.1	General	-----	4
2.2	Mechanical Characteristics	-----	4
2.3	Absolute Maximum Ratings	-----	5
2.4	Electrical Characteristics	-----	5
2.5	Optical Characteristics Absolute maximum ratings	-----	5
2.6	Optical Characteristics	-----	6
2.7	LED Back-light Characteristics	-----	7
3	LED Description	-----	8
4	Reliability	-----	13
5	Operating Instructions	-----	14
5.1	Input signal Function	-----	14
5.2	Voltage Generator Circuit	-----	15
5.3	Timing Diagram	-----	16
5.4.	Display Command	-----	17
6	Relationship between Character Code(DDRAM) and Character Pattern(CGRAM)	-----	18
7	Character Pattern	-----	19
8	Package information	-----	20
9	Notes	-----	21
10	Operation Precautions	-----	21
11	LCM Dimensions	-----	22

Appendix : Inspection Standard



1. SCOPE

This specification covers the engineering requirements for the GFC2002P-BNFEJSB04 liquid crystal module.

2. PRODUCT SPECIFICATIONS

2.1 General

- 20 × 2 dot matrix LCD
- STN(Blue), Negative mode LCD panel
- Transmissive , Wide temperature type
- 6 o'clock
- Multiplexing driving : 1/16duty, 1/5bias
- Controller IC : ST7066U-0A or Compatible
- Backlight: White

2.2 Mechanical Characteristics

Item	Characteristic
Dot configuration	20 × 2
Character Format	5X8 Dots
Character Pitch	2.5(W)X5.34(H)
Character Size	1.95(W) X4.51(H)
Dot size	0.35(W)X0.52(H)
Dot pitch	0.4(W)X0.57(H)
Module dimensions (Horizontal × Vertical × Thickness, mm)	72 (W)X32(H)X11.5 MAX(T)
Viewing area (Horizontal × Vertical, mm)	54(W) X 15(H)
Active area (Horizontal × Vertical, mm)	49.45(W)X9.85(H)
Remark	LED(藍 D3 , 藍+紅 D2)加熱縮套管



2.3 Absolute Maximum Ratings (Without LED back-light)

Characteristic	Symbol	Unit	Value
Operating Voltage (logic)	V_{DD}	V	-0.3 to +5.0
Input Voltage	V_{IN}	V	-0.3 to $V_{DD}+0.3$

Note 1: Referenced to $V_{SS}=0V$

2.4 Electrical Characteristics (Without LED back-light)

Characteristic	Symbol	Condition	Min.	Typ.	Max.	Unit
Operating Voltage(logic)	$V_{DD}-V_{SS}$	--	4.5	5.0	5.5	V
Input Voltage	V_{IH}	--	$0.8V_{DD}$	--	V_{DD}	V
	V_{IL}	--	V_{SS}	--	$0.2V_{DD}$	
Output Voltage	V_{OH}	$I_{OH}=-0.1mA$	$0.8V_{DD}$	--	V_{DD}	V
	V_{HL}	$I_{OL}=0.1mA$	V_{SS}	--	$0.2V_{DD}$	
Current Consumption	I_{DD}	$V_{IN}=V_{DD}$	--	0.05	1	mA

2.5 Optical Characteristics Absolute maximum ratings

Item	Symbol	Rating	Unit
Operating temperature range	T_{op}	-20~70	°C
Storage temperature range	T_{st}	-30~80	°C



2.6. Optical Characteristics

1/16 duty, 1/5 bias, $V_{op}=4.4V$, $T_a=25^\circ C$

Item	Symbol	Conditions	Min.	Typ.	Max	Reference
Driving voltage	V_{op}		4.1	4.4	4.7	
Viewing angle	θ_1, θ_2	$C \geq 2.0, \phi = 0^\circ$ C	30°	-		Notes 1 & 2
Contrast	C	$\theta = 5^\circ, \phi = 0^\circ$	3.0	-	-	Note 3
Response time(rise)	t_{on}	$\theta = 5^\circ, \phi = 0^\circ$	-	80	160ms	Note 4
Response time(fall)	t_{off}	$\theta = 5^\circ, \phi = 0^\circ$	-	100	200ms	Note 4

Note 1: Definition of angles θ and ϕ

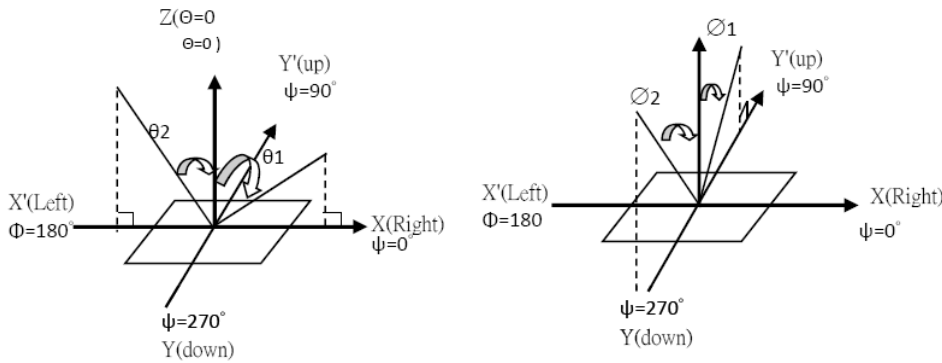

Note 2: Definition of viewing angles θ_1 and θ_2

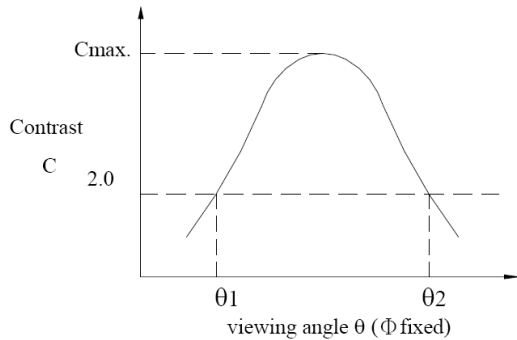

Note: Optimum viewing angle with the naked eye and viewing angle θ at C_{max} . Above are not always the same

Note 3: Definition of contrast C

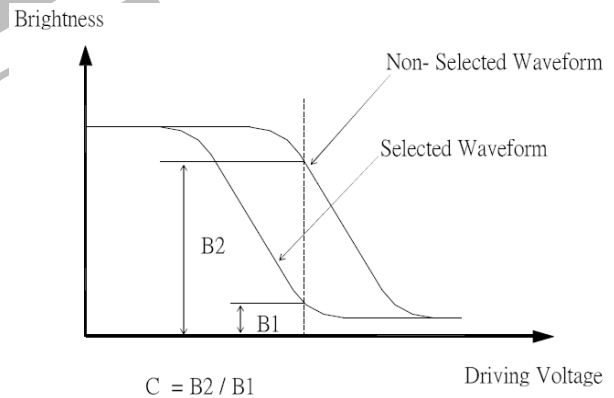

Note 4: Definition of response time

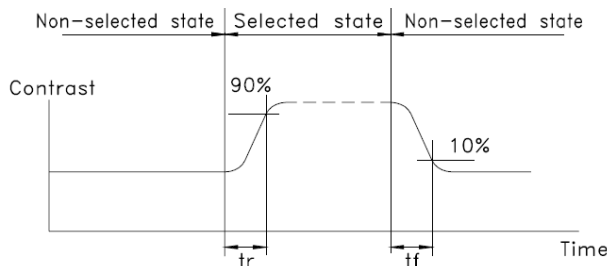

Note: Measured with a transmissive LCD panel which is displayed 1 cm^2

V_{OPR} : Operating voltage f_{FRM} : Frame frequency
 t_{ON} : Response time (rise) t_{OFF} : Response time (fall)



2.7 LED Back-light Characteristics

2.7.1 Electrical / optical specifications

Ta = 25°C

Item	Symbol	Condition	Min.	Typ.	Max.	Unit
Forward voltage	V _f	I _f =60mA, White	2.8	3.1	3.4	V
LED *Luminous Intensity	I _v	I _f =60mA, White	1100	1600		cd/m ²
Chromaticity Coordinate	x	I _f =60mA, White	0.26	-	0.32	
	y		0.26	-	0.32	
Uniformity	Avg	I _f =60mA, White	70			%
Reverse Current	I _R	V _R =5V, White	--	10	--	uA

Note: * Measured at the bare LED back-light unit.

2.7.2 LED Maximum Operating Range

Item	Symbol	WHITE	Unit
Power Dissipation	P _{AD}	198	mW
Forward Current	I _F	60	mA
Reverse Voltage	V _R	5	V



3. LED Description

3.1 D3 Description

This blue lamp is made with InGaN chip and water clear epoxy resin.

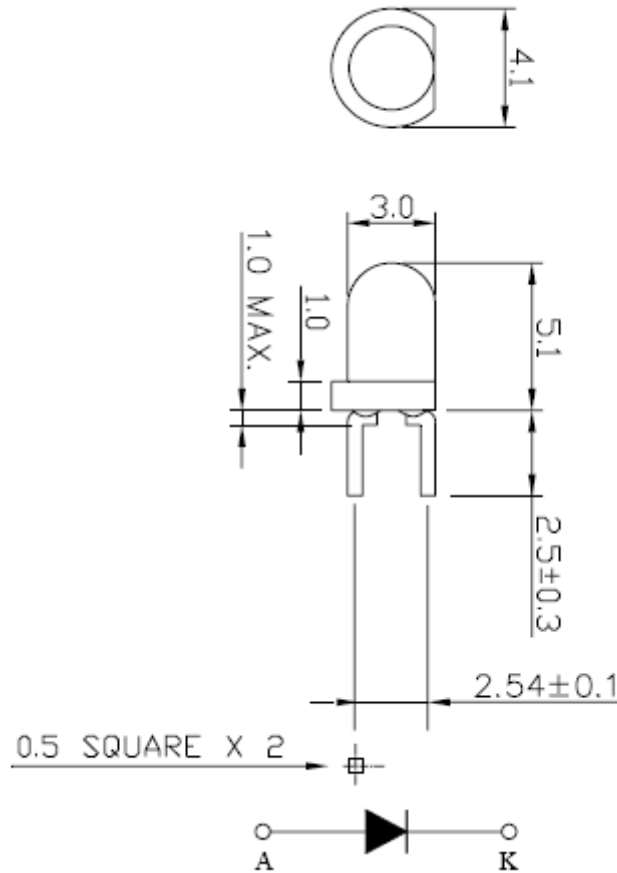

- Notes:**
1. All dimensions are in mm.
 2. The specifications, characteristics and technical data described in the datasheet are subject to change without notice.
 3. Tolerance is ±0.25mm unless otherwise noted.

Description

LED Chip		Lens Color
Material	Emitting Color	
InGaN	Blue	Water clear



3.1.1 Absolute Maximum Ratings at Ta=25°C

Parameter	Symbol	Rating	Unit
Power Dissipation	PD	120	mW
Reverse Voltage	VR	5	V
D.C. Forward Current	If	30	mA
Reverse (Leakage) Current	Ir	50	μA
Peak Current(1/10Duty Cycle,0.1ms Pulse Width.)	If(Peak)	100	mA
Operating Temperature Range	Topr.	-25 to +85	°C
Storage Temperature Range	Tstg.	-40 to +100	°C
Soldering Temperature(1.6mm from body)	Tsol.	Dip Soldering : 260°C for 5 sec. Hand Soldering : 350°C for 3 sec.	
Electrostatic discharge	ESD	6000	V

3.1.2 Electrical and Optical Characteristics:

Parameter	Symbol	Condition	Min.	Typ.	Max.	Unit
Luminous Intensity	IV	If=20mA	1000	5000		cd/m ²
Forward Voltage	Vf	If=20mA		3.2	4.0	V
Dominant Wavelength	λd	If=20mA		465		nm
Reverse (Leakage) Current	Ir	Vr=5V			50	μA
Viewing Angle	2θ1/2	If=20mA		30		deg
Spectrum Line Halfwidth	Δλ	If=20mA		26		nm



3.2 D2 Description

This blue and red bi-color lamp is made with InGaN blue chip, AlGaInP hyper red chip and water clear epoxy resin.

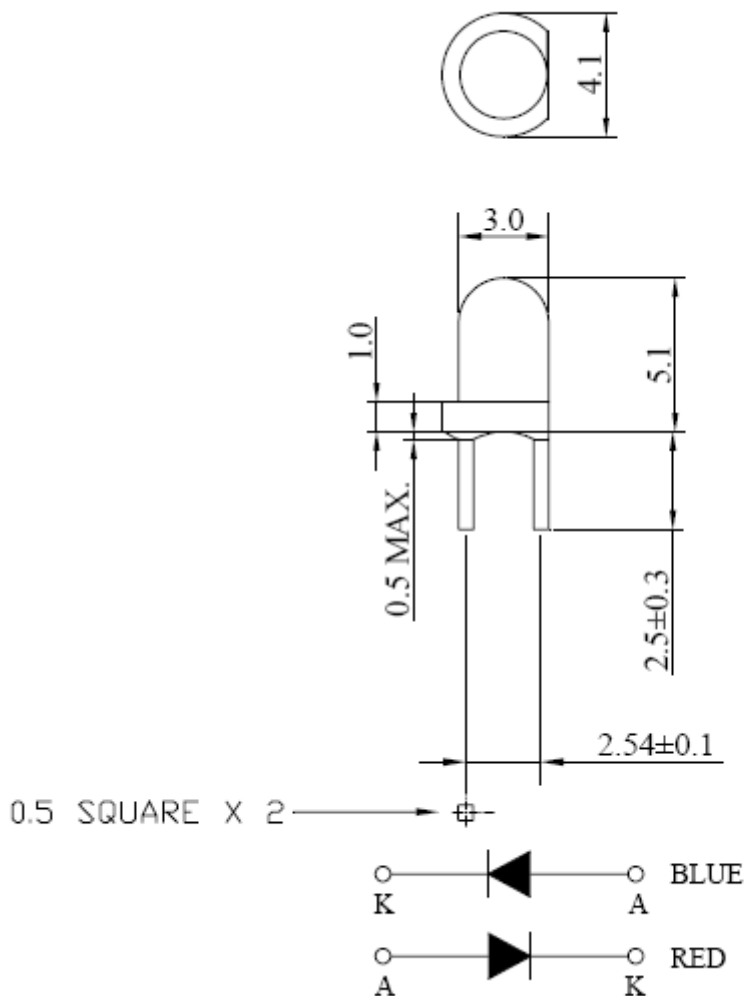

Notes:

1. All dimensions are in mm.
2. Tolerance is ±0.25mm unless otherwise noted.

Description

LED Chip		Lens Color
Material	Emitting Color	
InGaN	Blue	Water clear
AlGaInP/GaAs	Hyper red	



3.2.1 Absolute Maximum Ratings at Ta=25°C

Parameter	Symbol	Rating	Unit
Power Dissipation	PD	120	mW
Reverse Voltage	VR	5	V
D.C. Forward Current	If	30	mA
Reverse (Leakage) Current	Ir	50	μA
Peak Current(1/10Duty Cycle,0.1ms Pulse Width.)	If(Peak)	100	mA
Operating Temperature Range	Topr.	-25 to +85	°C
Storage Temperature Range	Tstg.	-40 to +100	°C
Soldering Temperature(1.6mm from body)	Tsol.	Dip Soldering : 260°C for 5 sec. Hand Soldering : 350°C for 3 sec.	
Electrostatic discharge	ESD.	1000	V

3.2.2 Electrical and Optical Characteristics:

Blue

Parameter	Symbol	Condition	Min.	Typ.	Max.	Unit
Luminous Intensity	IV	If=20mA	35.0	60.0		mcd
Forward Voltage	Vf	If=20mA		3.2	4.0	V
Dominant Wavelength	λd	If=20mA		465		nm
Reverse (Leakage) Current	Ir	Vr=5V			50	μA
Viewing Angle	2θ1/2	If=20mA		50		deg
Spectrum Line Halfwidth	Δλ	If=20mA		26		nm

Notes:1. Tolerance of Luminous Intensity is ±15%

2. Tolerance of Forward Voltage is ±0.1V

3. Tolerance of Dominant Wavelength is ±1nm

4. Customer's special requirements are also welcome.



3.2.3 Absolute Maximum Ratings at Ta=25°C

Parameter	Symbol	Rating	Unit
Power Dissipation	PD	72	mW
Reverse Voltage	VR	5	V
D.C. Forward Current	If	30	mA
Reverse (Leakage) Current	Ir	100	μA
Peak Current(1/10Duty Cycle,0.1ms Pulse Width.)	If(Peak)	100	mA
Operating Temperature Range	Topr.	-25 to +85	°C
Storage Temperature Range	Tstg.	-40 to +100	°C
Soldering Temperature(1.6mm from body)	Tsol.	Dip Soldering : 260°C for 5 sec. Hand Soldering : 350°C for 3 sec.	

3.2.4 Electrical and Optical Characteristics:

Hyper red

Parameter	Symbol	Condition	Min.	Typ.	Max.	Unit
Luminous Intensity	IV	If=20mA	30.0	70.0		mcd
Forward Voltage	Vf	If=20mA		1.9	2.4	V
Peak Wavelength	λp	If=20mA		632		
Dominant Wavelength	λd	If=20mA		625		nm
Reverse (Leakage) Current	Ir	Vr=5V			100	μA
Viewing Angle	2θ1/2	If=20mA		50		deg
Spectrum Line Halfwidth	Δλ	If=20mA		20		nm

Notes:1. Tolerance of Luminous Intensity is ±15%

2. Tolerance of Forward Voltage is ±0.1V

3. Tolerance of Dominant Wavelength is ±1nm

4. Customer's special requirements are also welcome.



4. RELIABILITY

NO.	ITEM	CONDITION		STANDARD	NOTE
1	High Temp. Storage	80°C	120 hrs	Appearance Without defect	
2	Low Temp. Storage	-30°C	120 hrs	Appearance Without defect	
3	High Temp. & High Humi. Storage	40°C 90% RH	120 hrs	Appearance Without defect	
4	High Temp. Operating Display	70°C	120 hrs	Appearance Without defect	
5	Low Temp. Operating Display	-20°C	120 hrs	Appearance Without defect	
6	Thermal Shock	-20°C, 30min. → 70°C, 30min. 		Appearance Without defect	10 cycles

** Dissipation current, contrast and display functions

** Polarizing filter deterioration, other appearance defects

** The function test shall be conducted after 4hours storage at the normal temperature and humidity after remove from the test chamber.



5. OPERATING INSTRUCTIONS

5.1 Input signal Function

NO.	Symbol	Function
1	VSS	Ground (0V)
2	VDD	Power supply for Logic circuit
3	VO	Power Supply for Driving the LCD
4	RS	Data / Instruction select
5	R/W	Read / Write select
6	E	Enable signal
7-14	DB0-DB7	Data Bus line
15	LED+	Power supply for LED backlight (+)
16	LED-	Power supply for LED backlight (-)
17	KAP1	S1 and S2 Key Scan
18	KAP2	S2 and S3 Key Scan
19	KAP3	S3 and S4 Key Scan
20	KAP4	S1 and S4 Key Scan
21	CT_GRN	LED D2 RED (-) OR BLUE (+)
22	NC	NC
23	NC	NC
24	CTR_YELL	LED D2 RED (+) OR BLUE (-)



5.2 Voltage Generator Circuit

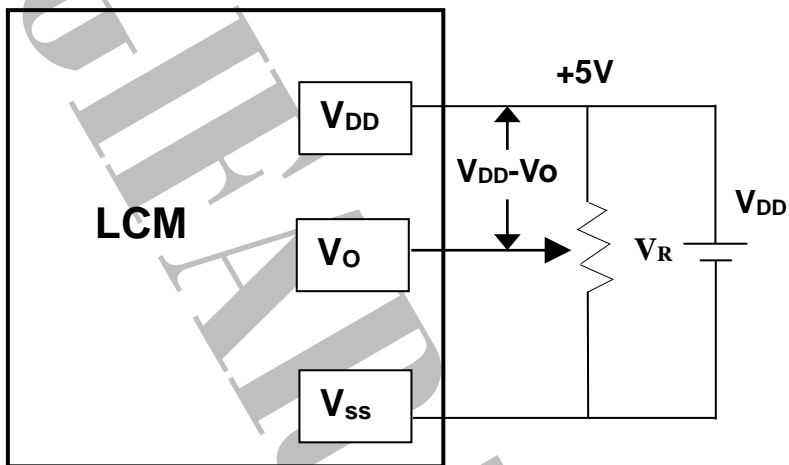

$V_{DD}-V_o$: LCD Driving Voltage
 V_R : 10K~20K



5.3 Timing Diagram

Writing data from MPU to ST7066U

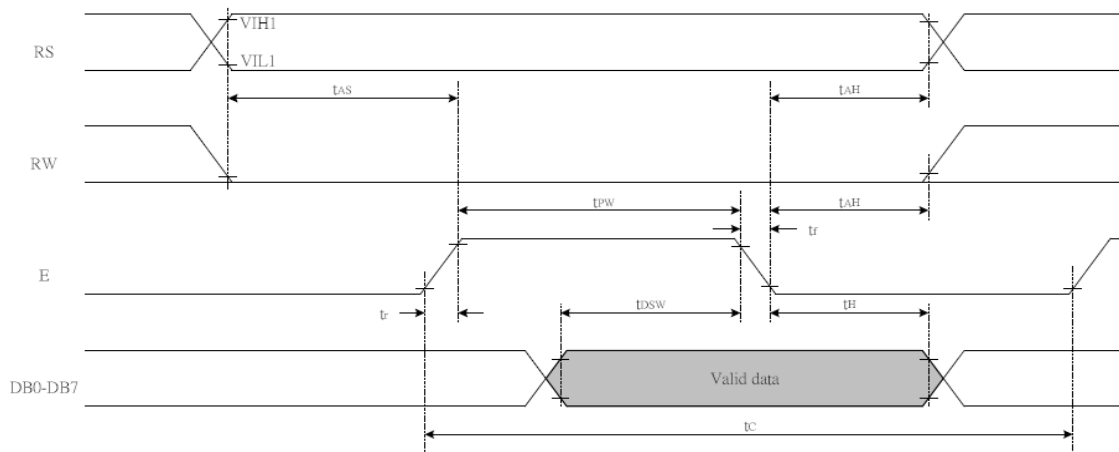

Write Mode (Writing data from MPU to ST7066U)

T_C	Enable Cycle Time	Pin E	1200	-	-	ns
T_{PW}	Enable Pulse Width	Pin E	140	-	-	ns
T_R, T_F	Enable Rise/Fall Time	Pin E	-	-	25	ns
T_{AS}	Address Setup Time	Pins: RS,RW,E	0	-	-	ns
T_{AH}	Address Hold Time	Pins: RS,RW,E	10	-	-	ns
T_{DSW}	Data Setup Time	Pins: DB0 - DB7	40	-	-	ns
T_H	Data Hold Time	Pins: DB0 - DB7	10	-	-	ns

Reading data from ST7066U to MPU

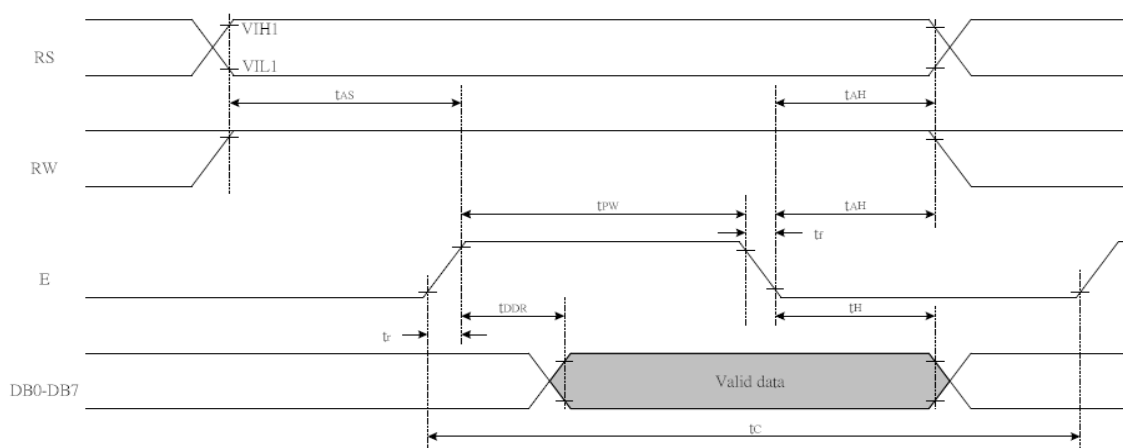

Read Mode (Reading Data from ST7066U to MPU)

T_C	Enable Cycle Time	Pin E	1200	-	-	ns
T_{PW}	Enable Pulse Width	Pin E	140	-	-	ns
T_R, T_F	Enable Rise/Fall Time	Pin E	-	-	25	ns
T_{AS}	Address Setup Time	Pins: RS,RW,E	0	-	-	ns
T_{AH}	Address Hold Time	Pins: RS,RW,E	10	-	-	ns
T_{DDR}	Data Setup Time	Pins: DB0 - DB7	-	-	100	ns
T_H	Data Hold Time	Pins: DB0 - DB7	10	-	-	ns



5.4. Display Command

Instruction	Instruction Code										Description	Description Time (270KHz)	
	RS	R/W	DB7	DB6	DB5	DB4	DB3	DB2	DB1	DB0			
Clear Display	0	0	0	0	0	0	0	0	0	0	1	Write "20H" to DDRAM. and set DDRAM address to "00H" from AC	1.52 ms
Return Home	0	0	0	0	0	0	0	0	0	1	x	Set DDRAM address to "00H" from AC and return cursor to its original position if shifted. The contents of DDRAM are not changed.	1.52 ms
Entry Mode Set	0	0	0	0	0	0	0	0	1	I/D	S	Sets cursor move direction and specifies display shift. These operations are performed during data write and read.	37 us
Display ON/OFF	0	0	0	0	0	0	0	1	D	C	B	D=1:entire display on C=1:cursor on B=1:cursor position on	37 us
Cursor or Display Shift	0	0	0	0	0	0	1	S/C	R/L	x	x	Set cursor moving and display shift control bit, and the direction, without changing DDRAM data.	37 us
Function Set	0	0	0	0	0	1	DL	N	F	x	x	DL:interface data is 8/4 bits N:number of line is 2/1 F:font size is 5x11/5x8	37 us
Set CGRAM address	0	0	0	1	AC5	AC4	AC3	AC2	AC1	AC0		Set CGRAM address in address counter	37 us
Set DDRAM address	0	0	1	AC6	AC5	AC4	AC3	AC2	AC1	AC0		Set DDRAM address in address counter	37 us
Read Busy flag and address	0	1	BF	AC6	AC5	AC4	AC3	AC2	AC1	AC0		Whether during internal operation or not can be known by reading BF. The contents of address counter can also be read.	0 us
Write data to RAM	1	0	D7	D6	D5	D4	D3	D2	D1	D0		Write data into internal RAM (DDRAM/CGRAM)	37 us
Read data from RAM	1	1	D7	D6	D5	D4	D3	D2	D1	D0		Read data from internal RAM (DDRAM/CGRAM)	37 us

※ "x":don't care



6. Relationship between Character Code(DDRAM) and Character Pattern(CGRAM)

Figure 1

Character Code (DDRAM data)								CGRAM Address						CGRAM Data								Pattern number
D7	D6	D5	D4	D3	D2	D1	D0	A5	A4	A3	A2	A1	A0	P7	P6	P5	P4	P3	P2	P1	P0	
0	0	0	0	x	0	0	0	0	0	0	0	0	0	x	x	x	0				0	pattern 1
											0	0	1					0	0	0		
											0	1	0					0	0	0		
											0	1	1					0	0	0		
											1	0	0					0	0	0		
											1	0	1					0	0	0		
											1	1	0					0	0	0		
											1	1	1				0	0	0	0	0	
0	0	0	0	x	1	1	1	1	1	1	0	0	0	x	x	x		0	0	0		pattern 8
											0	0	1					0	0	0		
											0	1	0					0	0	0		
											0	1	1					0	0	0		
											1	0	0					0	0	0		
											1	0	1					0	0	0		
											1	1	0					0	0	0		
											1	1	1				0	0	0	0	0	

*"x": dont care



7. Character Pattern

NO.7066-0A

b7-b4 b3-b0	0000	0001	0010	0011	0100	0101	0110	0111	1000	1001	1010	1011	1100	1101	1110	1111
0000	CG RAM (1)			0	a	P	^	P				-	9	E	o	p
0001	(2)		!	1	A	Q	a	A			.	7	7	6	ä	q
0010	(3)		"	2	B	R	b	r			7	4	9	x	p	ö
0011	(4)		#	3	C	S	c	s			7	7	7	e	s	ø
0100	(5)		\$	4	D	T	d	t			7	7	7	t	p	o
0101	(6)		%	5	E	U	e	u			.	7	7	7	7	ö
0110	(7)		&	6	F	V	f	v			7	7	7	7	7	ö
0111	(8)		^	7	G	W	g	w			7	7	7	7	7	ö
1000	(1)		^	8	H	X	h	x			7	7	7	7	7	ö
1001	(2)		^	9	I	Y	i	y			7	7	7	7	7	ö
1010	(3)		^	*	J	Z	j	z			7	7	7	7	7	ö
1011	(4)		^	+	K	L	k	l			7	7	7	7	7	ö
1100	(5)		^	,	<	L	7	l			7	7	7	7	7	ö
1101	(6)		^	-	=	M	7	m			7	7	7	7	7	ö
1110	(7)		^	.	>	N	7	n			7	7	7	7	7	ö
1111	(8)		^	/	?	O	7	o			7	7	7	7	7	ö



8. PACKAGE INFORMATION

1	1 Tray	:	24 pcs (modules)
2	1 stack	:	6 tray +1 Cover tray
3	1 Carton	:	(1 Cover tray + 6 tray)x 3 stack
4	Total pcs	:	1 Carton (24pcs*6tray * 3 stack) = 432 pcs
5	Carton size = NO. 17	:	495*315*435mm
7	Net weight	:	7.6 KG
8	Gross weight	:	11.5 KG

** Illustration

- 1 Tray= 24 pcs (modules)



- 1 stack=6 tray+1 Cover tray

**Each layer of tray should be staggered stacked



- 1 Carton = 3 stack, Total pcs = 432 pcs





9. NOTES

▪ Safety

- If the LCD panel breaks, be careful not to get the liquid crystal in your mouth. If the liquid crystal touches your skin or clothes, wash it off immediately using soap and plenty of water.

Handling

- Avoid static electricity as this can damage the CMOS LSI.
- The LCD panel is plate glass; do not hit or crush it.
- Do not remove the panel or frame from the module.
- The polarizing plate of the display is very fragile; handle it very carefully

Mounting and Design

- Mount the module by using the specified mounting part and holes.
- To protect the module from external pressure, leave a small gap by placing transparent plates (e.g. acrylic or glass) on the display surface, frame, and polarizing plate
- Design the system so that no input signal is given unless the power-supply voltage is applied.
- Keep the module dry. Avoid condensation, otherwise the transparent electrodes may break.

Storage

- Store the module in a dark place where the temperature is $25\text{ }^{\circ}\text{C}\pm 10\text{ }^{\circ}\text{C}$ and the humidity below 65% RH.
- Do not store the module near organic solvents or corrosive gases.
- Do not crush, shake, or jolt the module (including accessories).

Cleaning

- Do not wipe the polarizing plate with a dry cloth, as it may scratch the surface.
- Wipe the module gently with soft cloth soaked with a petroleum benzine.
- Do not use ketonic solvents (ketone and acetone) or aromatic solvents (toluene and xylene), as they may damage the polarizing plate.

10. OPERATION PRECAUTIONS

Any changes that need to be made in this specification or any problems arising from it will be dealt with quickly by discussion between both companies.

Quality warranty period: Within one year after shipment date (excluding abnormal usage way and abnormal environments.)



11. LCM Dimension

ROHS

NOTES:

- DRIVE METHOD: 1/16DUTY,1/5BIAS,VOP4,4V.
- VIEWING ANGLE: 6 0'CLOCK. (封口朝右)
- DISPLAY TYPE: STN(BLUE),TRANSMISSIVE/NEGATIVE.
- OPERATING TEMP: -20 TO 70°C.
- STORAGE TEMP: -30 TO 80°C.
- CONNECTION: ZEBRA (Large panel is on top layer.)
- CONTROLLER IC: ST7066U-0A, ST7063D.
- BACK LIGHT: WHITE(EDGE)LED 4pcs.
- NOT DIMENSION TOLERANCES IS ±0.2.

NO	NAME
1	VSS
2	VDD
3	V0
4	RS
5	R/W
6	E
7	DB0
8	DB1
9	DB2
10	DB3
11	DB4
12	DB5
13	DB6
14	DB7
15	LED+
16	LED-
17	KAP1
18	KAP2
19	KAP3
20	KAP4
21	CT_GRN
22	NC
23	NC
24	CTR_YELLOW

日期	版本	修改內容
141228	01	拿掉D11 LED
161229	02	修改公司抬頭為"晶發科技股份有限公司"

DATE	REV	Product	DRAWN	CHECKED	PAGE
2016.12.29 <td>02 <td>GFC2002P-BNFEJSB04 <td>Hazel <td>Donlin <td>1/1</td> </td></td></td></td>	02 <td>GFC2002P-BNFEJSB04 <td>Hazel <td>Donlin <td>1/1</td> </td></td></td>	GFC2002P-BNFEJSB04 <td>Hazel <td>Donlin <td>1/1</td> </td></td>	Hazel <td>Donlin <td>1/1</td> </td>	Donlin <td>1/1</td>	1/1

出貨檢驗標準書
Shipping inspection standard

核准 Approved by	審核 Checked by	作成 Made by
ANDY	JACKY	RUBY

1.目的 Purpose :

規範出貨產品之檢驗項目及判斷標準，確保產品出貨能滿足客戶要求。

Standardize the inspection items and judgment standards to ensure the products that shipped out can meet customer's requirements.

2.範圍 Area :

適用於出廠之所有產品。

Applicable to all products shipped from the factory.

3.名詞解釋 Explanation of terms :

3-1 主要缺陷：亦會造成功能缺失或嚴重外觀缺陷。

Major Defects: It also causes loss of function or serious appearance defects.

3-2 次要缺陷：稍有缺陷但不影響客戶使用。

Minor defect: Slightly defective but does not affect customer use.

4.檢驗體制 Inspection system :

4-1 抽樣計劃：依 ANSI/ASQ Z1.4 一般檢驗水準 II 之 正常檢驗一次抽驗方案。

Sampling plan: According to ANSI/ASQ Z1.4 general inspection level II the normal inspection one-time sampling plan.

4-2 允收水準 Acceptable Level : (AQL)

主要缺陷 Major defect : 0.4 %

次要缺陷 Minor defect : 0.65 %

5.檢驗條件 Inspection conditions :

5-1 使用相關之檢測儀器及測試、量測工具。

Use relevant testing instrument, testing and measuring tools .

5-2 環境要求：其條件需控制在常溫下 $23^{\circ}\text{C}\pm 3^{\circ}\text{C}$ 及溼度 70%RH 以下。

Environmental requirements: The conditions should be controlled at room temperature $23^{\circ}\text{C}\pm 3^{\circ}\text{C}$ and humidity below 70%RH.

5-3 外觀檢驗：須在 $380\pm 20\%$ LUX 的白色日光燈下，其目視距離需於產品離 30 ± 5 cm 檢驗。

Appearance inspection: Under the white fluorescent lamp of $380\pm 20\%$ LUX , the visual distance shall be checked above the product 30 ± 5 cm.

5-4 電性測試 Electrical Testing :

5-4-1 有背光之產品需關燈並在 $5\sim 300\text{Lux}\pm 3\%$ 下檢驗。

The products with backlight should be tested at $5\sim 300\pm 3\%$ Lux.

5-4-2 無背光之產品需開燈並在 $60\sim 300\text{Lux}\pm 3\%$ 白色日光燈下檢驗。

Products without backlight need to be turned on and tested under $60\sim 300 \pm 3\%$ LUX white fluorescent lamps .

5-5 檢查視角依產品視角方向。

Check the viewing angle according to the product viewing angle.

5-6 其不良現象檢視區域 Bad phenomenon View area

5-6-1 適用種類 Applicable category : COB、TFT

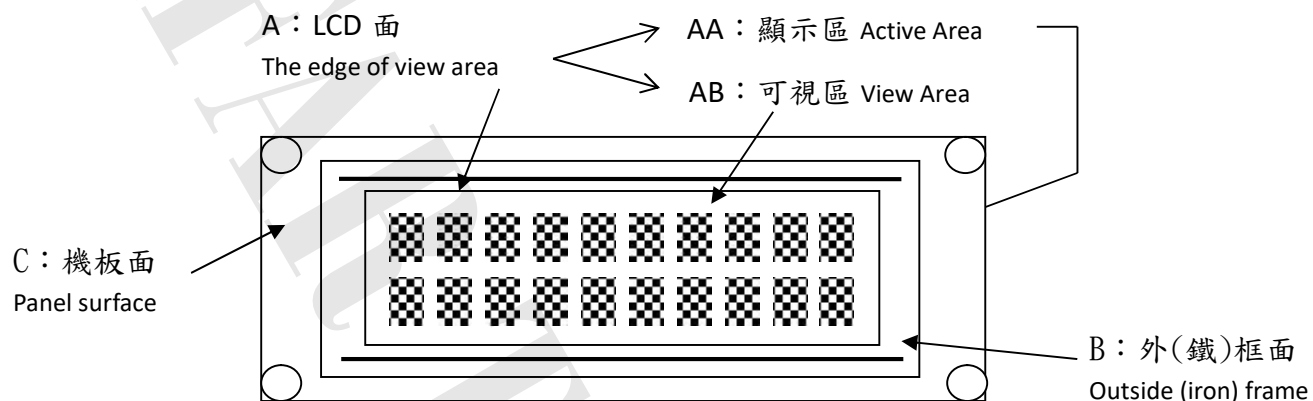

5-6-2 適用種類 Applicable category : COG、TAB、TN

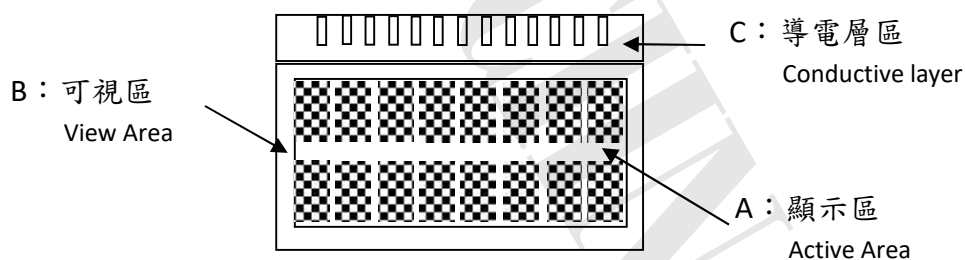

6. 檢驗標準 Inspection standards

COB

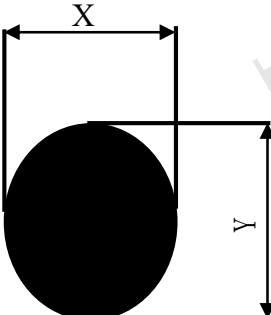
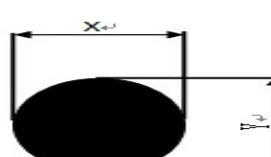
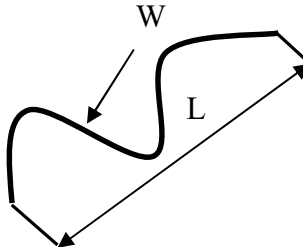
種類 Category		COB																			
編號 No.	檢驗項目 Item	檢驗內容及判定標準 Inspection Content & Standard	區域 Zone	類別 Category	缺陷等級 Level																
1	點類(一) Dot (1)	黑點、刺傷...等圓狀 Black dot、Stab...and other round shape $\varphi = \frac{(X + Y)}{2}$ 	兩點距離須超過 5 mm Two points have to be ≥ 5 mm <table border="1"> <thead> <tr> <th>φ (mm)</th> <th>允收數 Acceptance Qty</th> </tr> </thead> <tbody> <tr> <td>$\phi \leq 0.1$</td> <td>無視 Ignore</td> </tr> <tr> <td>$0.1 < \phi \leq 0.25$</td> <td>3</td> </tr> <tr> <td>$0.25 < \phi \leq 0.3$</td> <td>1</td> </tr> <tr> <td>$\phi > 0.3$</td> <td>0</td> </tr> </tbody> </table>	φ (mm)	允收數 Acceptance Qty	$\phi \leq 0.1$	無視 Ignore	$0.1 < \phi \leq 0.25$	3	$0.25 < \phi \leq 0.3$	1	$\phi > 0.3$	0	A	外觀 Appearance	次要 Minor AQL0.65%					
		φ (mm)	允收數 Acceptance Qty																		
$\phi \leq 0.1$	無視 Ignore																				
$0.1 < \phi \leq 0.25$	3																				
$0.25 < \phi \leq 0.3$	1																				
$\phi > 0.3$	0																				
其點位於側邊 無視 The dot is located on the side(B area)-OK <table border="1"> <thead> <tr> <th>φ (mm)</th> <th>允收數 Acceptance Qty</th> </tr> </thead> <tbody> <tr> <td>$\phi \leq 0.3$</td> <td>無視 Ignore</td> </tr> <tr> <td>$0.3 < \phi \leq 0.5$</td> <td>3</td> </tr> <tr> <td>$0.5 < \phi \leq 1$</td> <td>1</td> </tr> <tr> <td>$\phi > 1$</td> <td>0</td> </tr> </tbody> </table>	φ (mm)	允收數 Acceptance Qty	$\phi \leq 0.3$	無視 Ignore	$0.3 < \phi \leq 0.5$	3	$0.5 < \phi \leq 1$	1	$\phi > 1$	0	B	外觀 Appearance	次要 Minor AQL0.65%								
φ (mm)	允收數 Acceptance Qty																				
$\phi \leq 0.3$	無視 Ignore																				
$0.3 < \phi \leq 0.5$	3																				
$0.5 < \phi \leq 1$	1																				
$\phi > 1$	0																				
2	點類(二) Dot (2)	氣泡、凹凸點 Bubble、Uneven dots $\varphi = \frac{(X + Y)}{2}$ 	兩點距離須超過 5 mm Two points to be ≥ 5 mm <table border="1"> <thead> <tr> <th>φ (mm)</th> <th>允收數 Acceptance Qty</th> </tr> </thead> <tbody> <tr> <td>$\phi \leq 0.2$</td> <td>無視 Ignore</td> </tr> <tr> <td>$0.2 < \phi \leq 0.5$</td> <td>2</td> </tr> <tr> <td>$\phi > 0.5$</td> <td>0</td> </tr> </tbody> </table>	φ (mm)	允收數 Acceptance Qty	$\phi \leq 0.2$	無視 Ignore	$0.2 < \phi \leq 0.5$	2	$\phi > 0.5$	0	A	外觀 Appearance	次要 Minor AQL0.65%							
φ (mm)	允收數 Acceptance Qty																				
$\phi \leq 0.2$	無視 Ignore																				
$0.2 < \phi \leq 0.5$	2																				
$\phi > 0.5$	0																				
3	線類 Line	刮傷、毛屑...等線狀 Scratch、Fiber.. and other linear shape. 	<table border="1"> <thead> <tr> <th>L (mm)</th> <th>W (mm)</th> <th>允收數 Acceptance Qty</th> </tr> </thead> <tbody> <tr> <td>--</td> <td>$W \leq 0.02$</td> <td>無視 Ignore</td> </tr> <tr> <td>$L \leq 5$</td> <td>$W \leq 0.03$</td> <td>3</td> </tr> <tr> <td>$L \leq 3$</td> <td>$W \leq 0.05$</td> <td>2</td> </tr> <tr> <td>$L > 5$</td> <td>$W > 0.05$</td> <td>0</td> </tr> </tbody> </table>	L (mm)	W (mm)	允收數 Acceptance Qty	--	$W \leq 0.02$	無視 Ignore	$L \leq 5$	$W \leq 0.03$	3	$L \leq 3$	$W \leq 0.05$	2	$L > 5$	$W > 0.05$	0	A	外觀 Appearance	次要 Minor AQL0.65%
L (mm)	W (mm)	允收數 Acceptance Qty																			
--	$W \leq 0.02$	無視 Ignore																			
$L \leq 5$	$W \leq 0.03$	3																			
$L \leq 3$	$W \leq 0.05$	2																			
$L > 5$	$W > 0.05$	0																			
4	底色 Background color	同批供貨不能有明顯色差 No obvious color difference allowed in same shipment. (必要時與客端制定限度樣) (According to the gold samples if necessary)	A	外觀 Appearance	次要 Minor AQL0.65%																

5	零件位置 Parts position	與工程 BOM 上標示不符 拒收 Different with the BOM marked Reject	C	外觀 Appearance	主要 Major AQL 0.4%
6	板面潔淨 FPC/PCB's surface is clean	※ 焊接面上附著錫渣、珠 拒收 Solder side has tin slag, beads or particle Reject ※ 焊接面上附著於過多錫油 拒收 Solder side has too much tin oil Reject	C	外觀 Appearance	次要 Minor AQL0.65%
7	點、線類 (三) Dot、Line (3)	※ 於全黑、白畫面下看見之區塊狀或線狀不良 拒收 There is a block or linear in the view area under the screen is whole black or white. Reject ※ 但依 2% ND Filter 遮蓋無視 允收 But after inspecting by 2% ND Filter without seeing block or linear, it is confirmed Acceptance	AA	電訊 Electronics	次要 Minor AQL0.65%
8	點、線類 (四) Dot、Line (4)	畫面中顯示出現黑、白、亮、異色點或線狀 There is a black, white, bright or other dot or lines showing in the view area. ※ 依編號 1、3 之判定標準 According to the inspection standard: No. 1 and 3.	AA	電訊 Electronics	次要 Minor AQL0.65%
9	缺字 Lack of characters	顯示時畫面缺少部份字元 拒收 Lacking part of characters in the view area. Reject	AA	電訊 Electronics	主要 Major AQL 0.4%
10	無動作 No reaction	顯示畫面一直處於起始畫面而無法進行切換 拒收 The display (view area) always shows in the initial screen and can't be switched to others. Reject	AA	電訊 Electronics	主要 Major AQL 0.4%
11	無畫面 No display	通電後，完全無任何畫面顯示 拒收 After connecting to the power, there is no display. Reject	AA	電訊 Electronics	主要 Major AQL 0.4%
12	斷線 Broken line	顯示畫面中少直、橫線 拒收 There is a lack of vertical or horizontal lines in the view area. Reject	AA	電訊 Electronics	主要 Major AQL 0.4%
13	CROSS TALK	顯示畫面時有局部之條紋或拖影 There are some stripes or shadow/smear showing in the view area. 拒收或與客端簽訂限度樣 Reject or inspect according to the golden sample	AA	電訊 Electronics	次要 Minor AQL0.65%

14	I CON	顯示畫面缺少部份顯示圖案 拒收 Lack of partial ICON in the view area. Reject	AA	電訊 Electronics	主要 Major AQL 0.4%
15	深淺不一 Color difference	顯示畫面的對比，比其他顯示深或淺並依電氣規格(VOP)值判定 The contrast of display is obviously lighter or darker than others and according to the VOP value in the electronics specification. 拒收或與客端簽訂限度樣 Reject or inspect according to the golden sample	AA	電訊 Electronics	次要 Minor AQL0.65%
16	畫面異常 Abnormal screen	通電後畫面出現未定義之電訊不良現象 拒收 After connecting to the power, there is an undefined electronics appearance showing in the view area. Reject	AA	電訊 Electronics	主要 Major AQL 0.4%
17	背光色不均 Uneven color of backlight	※ 點亮後 LED 有明暗不均現象依其均勻度判定 拒收 After lighting LEDs have brightness and darkness uneven the determined according to its uniformity. Reject ※ 點亮後 LED 色澤不一致 拒收 LED color is inconsistent after lighting Reject	A	電訊 Electronics	次要 Minor AQL0.65%
18	亮度不足 Lack of brightness	波長、色座標、輝度與圖面標示定義不符 拒收 Wave length, chromatic coordinates, brightness don't correspond to the definition of the drawing. Reject	A	電訊 Electronics	次要 Minor AQL0.65%
19	尺寸量測 Size Measurement	未依圖面上標示 拒收 No correspond to the indication on the drawing. Reject	ALL	外觀 Appearance	主要 Major AQL 0.4%
20	其他 Other	如發現有上述未定義之不良則與客端簽訂限度樣 If there is another undefined defective situation. It will be listed as others. The inspection standard is according to the golden sample.	ALL	電訊 Electronics 外觀 Appearance	次要 Minor AQL0.65%